



Xenon™ Permanent Horizontal Lifeline Kits

User Instruction Manual

Manuel D'utilisation / Manual de Instrucciones para El Usuario

Table of Contents

1.0 Purpose.....	3
2.0 General Requirements, Warnings and Limitations.....	3-4
2.1 General Fall Protection Requirements	
2.2 System Warnings and Limitations	
3.0 Xenon Kit Diagrams and Component Descriptions.....	5-6
4.0 Installation of Xenon Horizontal Lifeline Kits.....	7-11
4.1 Installation of D-Bolt Anchor to Beam or Structure	
4.2 Installation of Universal Intermediate Brackets	
4.3 Installation of Horizontal Lifeline Assembly	
4.4 Tensioning Horizontal Lifeline	
4.5 Installation of a Second Shock Absorber	
5.0 Operation/Use of Xenon Shuttle on the Horizontal Lifeline.....	12
6.0 Fall Clearance.....	13-14
7.0 Training.....	15
8.0 Inspection and Maintenance.....	15
Labels.....	15
Inspection and Maintenance Log.....	16
Warranty.....	17

Thank You

Thank you for your purchase of Miller Fall Protection equipment. Miller brand products are produced to meet the highest standards of quality at our ISO 9001 certified facility. Miller Fall Protection equipment will provide you with years of use when cared for properly.

WARNING

All persons using this equipment must read, understand and follow all instructions. Failure to do so may result in serious injury or death. Do not use this equipment unless you are properly trained.

Questions? CALL
1.800.873.5242

It is crucial that the authorized person/user of this fall protection equipment read and understand these instructions. In addition, it is the employer's responsibility to ensure that all users are trained in the proper use, inspection, and maintenance of fall protection equipment. Fall protection training should be an integral part of a comprehensive safety program.

Proper use of fall arrest systems can save lives and reduce the potential of serious injuries from a fall. The user must be aware that forces experienced during the arrest of a fall or prolonged suspension may cause bodily injury. Consult a physician if there is any question about the user's ability to use this product. Pregnant women and minors must not use this product.

1.0 Purpose

For use along crane rail runways, loading bays/docks, machinery maintenance conveyors, rooftops, pipe racks, bridges, inside sports arenas, and many industrial applications, the Xenon Permanent Horizontal Lifeline Kit provides fall protection that ultimately increases worker mobility, safety and productivity. The uniquely-designed Xenon Shuttle self-aligns to smoothly pass through intermediate brackets for 100% connection to the system.

2.0 General Requirements, Warnings and Limitations

2.1 General Fall Protection Requirements

All warnings and instructions shall be provided to authorized persons/users. Warnings and instructions must be read and understood prior to using this equipment.

All authorized persons/users must reference the regulations governing occupational safety, as well as applicable standards. Xenon Kits meet OSHA and ANSI A10.32-2004.

Proper precautions should always be taken to remove any obstructions, debris, material, or other recognized hazards from the work area that could cause injuries or interfere with the operation of the system.

All equipment must be inspected before each use according to the manufacturer's instructions.

All equipment should be inspected by a qualified person on a regular basis.

To minimize the potential for accidental disengagement, a competent person must ensure system compatibility.

Equipment must not be altered in any way. Repairs must be performed only by the equipment manufacturer, or persons or entities authorized, in writing, by the manufacturer.

Any product exhibiting deformities, unusual wear, or deterioration must be immediately discarded.

Any equipment subject to a fall must be removed from service.

The user shall have a rescue plan and the means at hand to implement it when using this equipment.

Never use fall protection equipment for purposes other than those for which it was designed. Fall protection equipment should never be used for towing or hoisting.

Never remove product labels, which include important warnings and information for the authorized person/user.

2.2 System Warnings and Limitations

System Compatibility

Xenon Kits are designed for use with Miller approved components. Substitution or replacement with non-approved component combinations, sub-systems, or both, may affect or interfere with the safe function of each other and endanger the compatibility within the system. This incompatibility may affect the reliability and safety of the total system.

Miller Fall Protection requires the use of a Miller full-body harness and shock-absorbing lanyard or self-retracting lifeline/fall limiter with this system. All instructions and warnings provided with the body wear and connecting device must be read and understood before using the equipment.

Maximum Lifeline Span

The maximum lifeline span (from anchor to anchor, from anchor to intermediate bracket, or from intermediate bracket to intermediate bracket) is 30 ft. (9.1m). System kits are available in lengths from 30 ft. (9.1m) to 510 ft. (155.5m). Any lifeline system extending beyond 30ft. (9.1m), known as a multiple-span system, requires intermediate brackets at a maximum of 30 ft. (9.1m) intervals.

Capacity

Maximum capacity is two (2) workers [310lbs (140.6kg) each] for a single shock absorber system and four (4) workers [310lbs (140.6kg) each] for a double shock absorber system. Capacity ratings assume the anchorage or structure to which the horizontal lifeline kit is installed meets the load requirements.

System Forces

The Xenon Kit is equipped with an inline shock absorber. In the event of a fall, the shock absorber limits system forces.

Fall Arrest Forces

In conjunction with the Xenon Horizontal Lifeline System, workers must use a Miller self-retracting lifeline/fall limiter or a shock-absorbing lanyard, which limits maximum fall arrest force imposed by the worker to 900lbf (4kN).

Free Fall

Personal fall arrest systems must be rigged to limit a free fall to the shortest possible distance [6ft (1.8m) maximum].

Fall Clearance

Ensure that adequate clearance exists in your fall path to avoid striking a lower level or other object (see 6.0 Fall Clearance).

Environmental Hazards

Use of this equipment in areas where environmental hazards exist may require additional precautions to limit the possibility of injury to the user or damage to the equipment. Hazards may include, but are not limited to, extreme temperatures, caustic chemicals, corrosive environments, high voltage power lines, explosive or toxic gases, moving machinery, and sharp edges. Do not expose the equipment to any hazard which it is not designed to withstand. Consult the manufacturer in cases of doubt.

System Requirements

The Horizontal Lifeline System shall be designed, installed and used, under the supervision of a qualified person, as part of a complete personal fall arrest system, which maintains a safety factor of at least two.

Ensure that there is adequate end and intermediate anchorage strength for the Xenon HLL System per the chart below. *Load requirements reflect a 2:1 safety factor.

End and Intermediate System Load Requirements* [lbf. (kN)] for Xenon HLL Systems				
Single-Span Systems				
System/ Span Length [ft. (m)]	Single Shock Absorber System for 1-2 Workers		Double Shock Absorber System for 3-4 Workers	
	End Load	Intermediate Load	End Load	Intermediate Load
10 (3m)	3294 lbf. (14.7kN)	2420 lbf. (10.8kN)	3790 lbf. (16.9kN)	3660 lbf. (16.3kN)
15 (4.5m)	3786 lbf. (16.8kN)	2420 lbf. (10.8kN)	4374 lbf. (19.5kN)	3660 lbf. (16.3kN)
20 (6.1m)	4330 lbf. (19.3kN)	2420 lbf. (10.8kN)	4910 lbf. (21.8kN)	3660 lbf. (16.3kN)
25 (7.6m)	4686 lbf. (20.8kN)	2420 lbf. (10.8kN)	5342 lbf. (23.8kN)	3660 lbf. (16.3kN)
30 (9.1m)	4968 lbf. (22.1kN)	2420 lbf. (10.8kN)	5812 lbf. (25.9kN)	3660 lbf. (16.3kN)
Multiple-Span Systems (with 30 ft. spans)				
System Length [ft (m)]	Single Shock Absorber System for 1-2 Workers		Double Shock Absorber System for 3-4 Workers	
	End Load	Intermediate Load	End Load	Intermediate Load
30 (9.1m)	4968 lbf. (22.1kN)	2420 lbf. (10.8kN)	5812 lbf. (25.9kN)	3660 lbf. (16.3kN)
60 (18.2m)	4692 lbf. (20.9kN)	2420 lbf. (10.8kN)	5556 lbf. (24.7kN)	3660 lbf. (16.3kN)
90 (27.4m)	4458 lbf. (19.8kN)	2420 lbf. (10.8kN)	5344 lbf. (23.8kN)	3660 lbf. (16.3kN)
120 (36.5m)	4302 lbf. (19.1kN)	2420 lbf. (10.8kN)	5192 lbf. (23.1kN)	3660 lbf. (16.3kN)
150 (45.7m)	4132 lbf. (18.4kN)	2420 lbf. (10.8kN)	5034 lbf. (22.4kN)	3660 lbf. (16.3kN)
180 (54.8m)	4006 lbf. (17.8kN)	2420 lbf. (10.8kN)	4910 lbf. (21.8kN)	3660 lbf. (16.3kN)
210 (64m)	3906 lbf. (17.4kN)	2420 lbf. (10.8kN)	4840 lbf. (21.5kN)	3660 lbf. (16.3kN)
240 (73.1m)	3794 lbf. (16.9kN)	2420 lbf. (10.8kN)	4716 lbf. (21kN)	3660 lbf. (16.3kN)
270 (82.2m)	3718 lbf. (16.5kN)	2420 lbf. (10.8kN)	4638 lbf. (20.6kN)	3660 lbf. (16.3kN)
300 (91.4m)	3640 lbf. (16.2kN)	2420 lbf. (10.8kN)	4550 lbf. (20.2kN)	3660 lbf. (16.3kN)
330 (100.5m)	3574 lbf. (15.9kN)	2420 lbf. (10.8kN)	4490 lbf. (20kN)	3660 lbf. (16.3kN)
360 (109.7m)	3504 lbf. (15.6kN)	2420 lbf. (10.8kN)	4414 lbf. (19.6kN)	3660 lbf. (16.3kN)
390 (118.8m)	3442 lbf. (15.3kN)	2420 lbf. (10.8kN)	4364 lbf. (19.4kN)	3660 lbf. (16.3kN)
420 (128m)	3388 lbf. (15.1kN)	2420 lbf. (10.8kN)	4304 lbf. (19.2kN)	3660 lbf. (16.3kN)
450 (137.1m)	3342 lbf. (14.9kN)	2420 lbf. (10.8kN)	4248 lbf. (18.9kN)	3660 lbf. (16.3kN)
480 (146.3m)	3290 lbf. (14.6kN)	2420 lbf. (10.8kN)	4196 lbf. (18.7kN)	3660 lbf. (16.3kN)
510 (155.4m)	3242 lbf. (14.4kN)	2420 lbf. (10.8kN)	4148 lbf. (18.5kN)	3660 lbf. (16.3kN)

3.0 Xenon Kit Diagrams and Component Descriptions

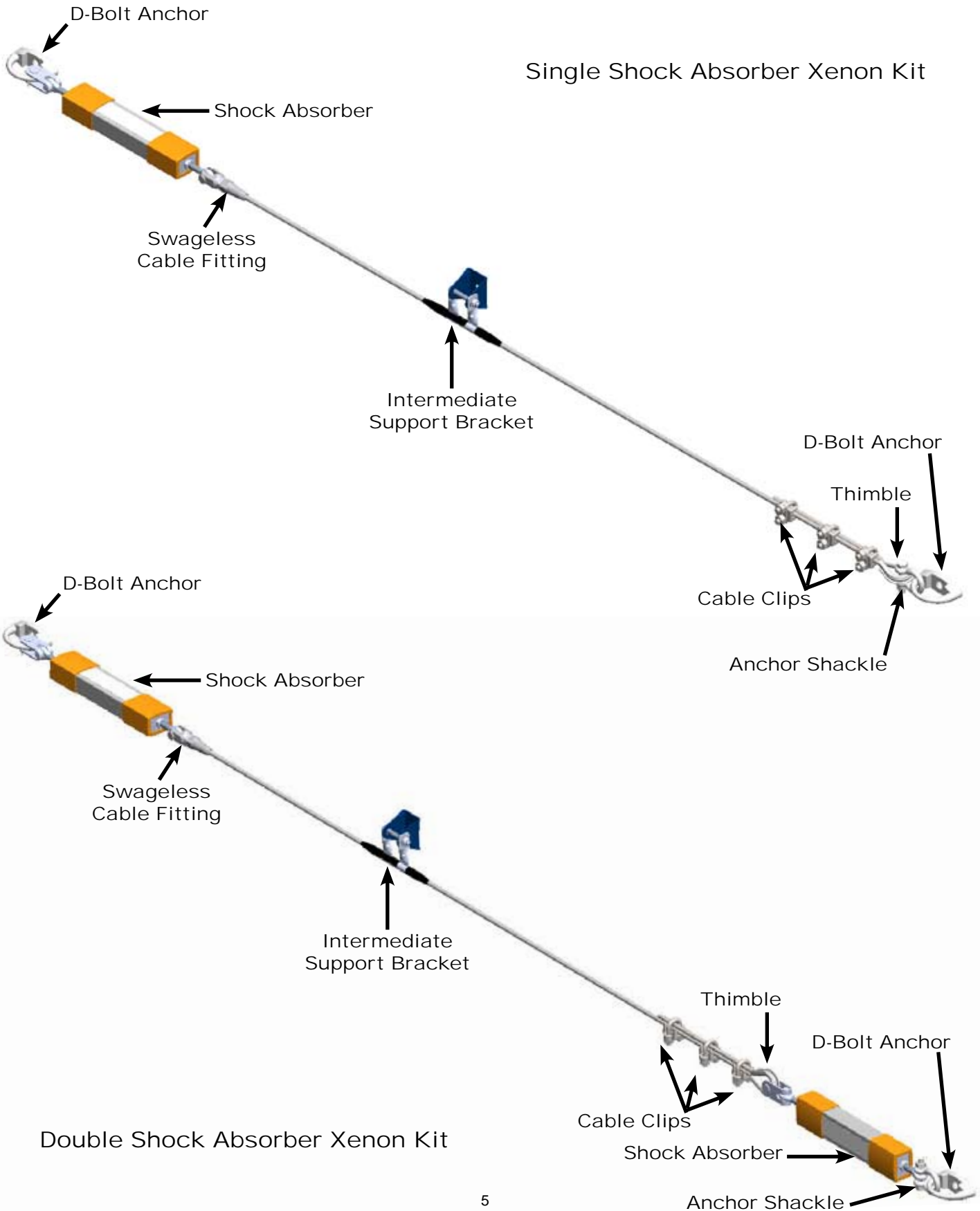

Part No.	Component Name	Qty.	Description
System Kit Components			
416SS	D-Bolt Anchor	2	5/8" (16mm) stainless steel D-anchor with hex bolt (5/8" - 11 UNC x 5"), hex nut and split lockwasher, rated to 10,000 lbs. (45kN)
417SS	D-Bolt Anchor	2	5/8" (16mm) stainless steel D-anchor, rated to 10,000 lbs. (45kN) <i>(Fasteners not included--The 417 D-Bolt Anchor must only be used with an approved 5/8" - 11 UNC hex bolt, hex nut and split lockwasher.)</i>
1014934	Xenon 4-in-1 Shock Absorber	1 or 2*	Multi-purpose shock absorber acts as an inline shock absorber, turnbuckle, tension indicator and fall indicator
1013720	Fast Attach Cable Fitting	1	Stainless steel, swageless cable fitting for 5/16" (8mm) wire rope
XC00030	Cable Lifeline	1	5/16" (8mm) diameter stainless steel wire rope, 30' (9.1m) length <i>(Part no. will change depending on length specified. Example: XC00120 = 120' (36.5m) cable lifeline)</i>
XP00001	Thimble	1	Stainless steel thimble
XP00002	Cable Clip	3	5/16" (8mm) wire rope clip
SGAS-SS	Anchor Shackle	1	7/16" (11mm) stainless steel shackle with bolt, nut and cotter pin
1010608	Universal Intermediate Bracket	Varies	Intermediate support bracket allows for free floating or locked positioning and easy passage of Xenon shuttle; includes 1/2" (13mm) x 3" (76mm) long stainless steel bolt, nut and washer
1010609	Universal Intermediate Bracket	Varies	Intermediate support bracket allows for free floating or locked positioning and easy passage of Xenon shuttle <i>(Hardware not included)</i>
Optional System Components			
1005709	Xenon Shuttle	Varies	Shuttle with stainless steel attachment ring; self-aligns for smooth pass-through of intermediate brackets

*A second shock absorber may be added to accommodate three (3) to four (4) workers on the horizontal lifeline system.

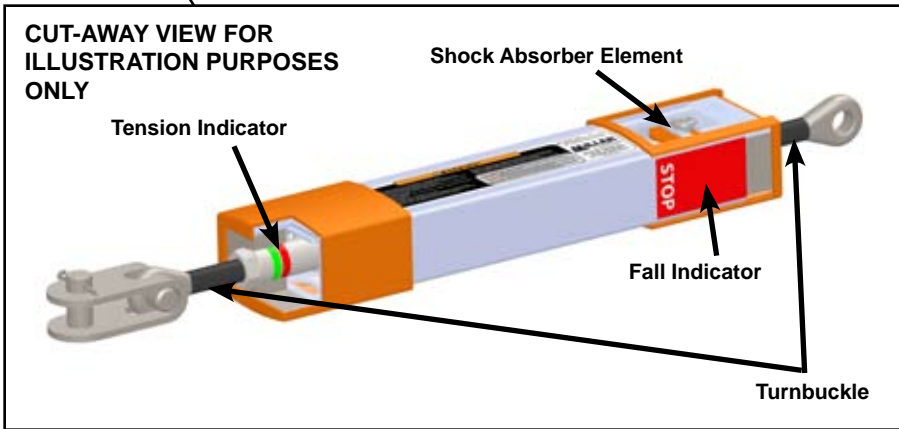
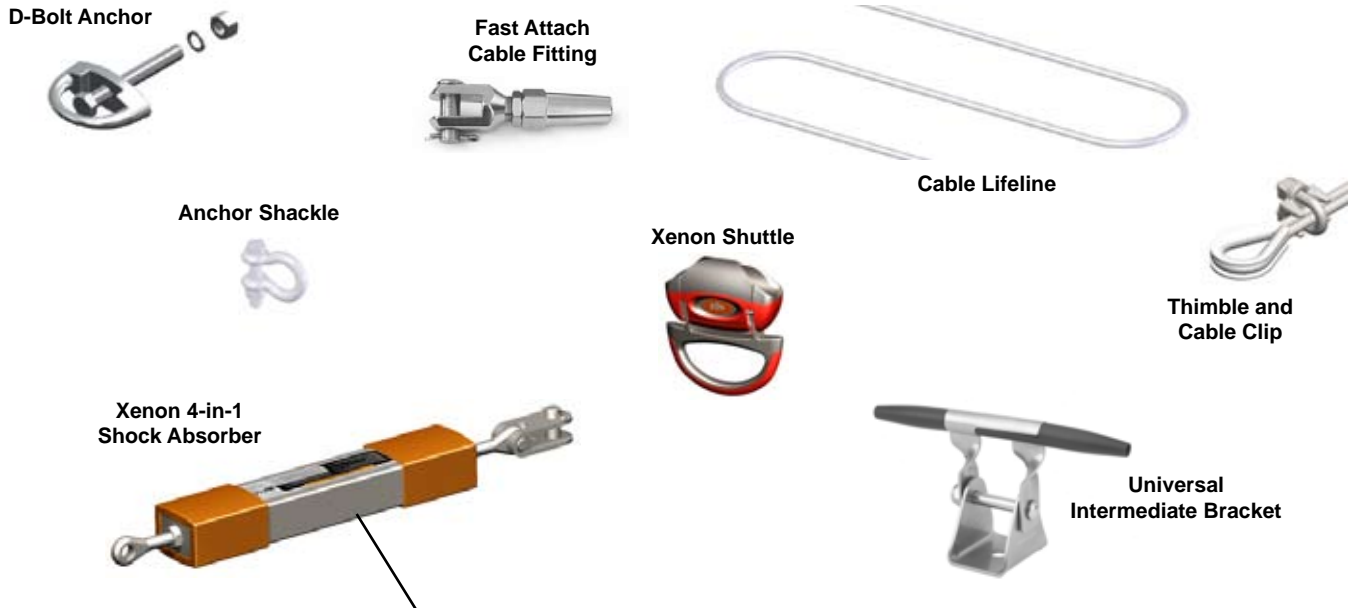

4.0 Installation of Xenon Horizontal Lifeline Kits

- Before installation, carefully inspect all components of the system according to the manufacturer's instructions (see 8.0 Inspection and Maintenance).
- Ensure that there is sufficient fall clearance below the work surface to avoid hitting a lower level or obstruction (see 6.0 Fall Clearance).
- If installing the system off-the-ground, a personal fall arrest system including an anchorage connector, such as a Miller beam anchor, must be used. Once a D-bolt anchor has been completely installed and secured to the beam or structure given the required specifications, a worker may tie-off onto the anchor.
- Some system components may come preassembled. Installation instructions still must be followed to ensure all components are included and properly assembled. All fasteners and connectors must be checked for correct alignment and installation and tightened to required specifications.

4.1 Installation of D-Bolt Anchor to Beam or Structure

NOTE: 416 D-Bolt Anchor shown; 417 D-Bolt Anchor does not include fasteners.

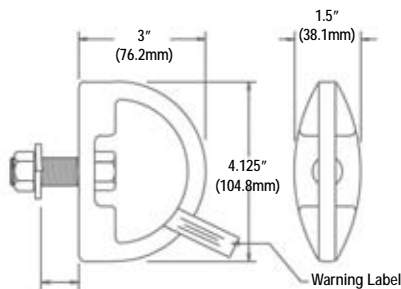

Working Thickness up to 4" (101.6mm)
[417 D-Bolt Anchor can be mounted with a longer 5/8" (16mm) bolt to accommodate greater thicknesses.]

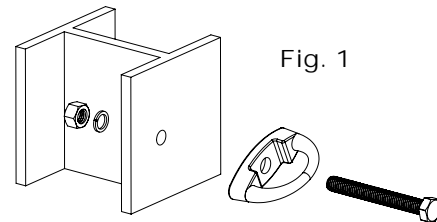

Fig. 1

1. Locate and identify an approved compatible anchorage. The beam or structure to which this product is attached must be capable of supporting the loads specified in Section 2.2 of this manual in the direction of pull. Be sure that the mounting location is clean and free of debris.
2. Locate or drill a 21/32" (16.7mm) diameter hole. Consideration should be given to allow sufficient clearance to place the lockwasher and tighten the nut.

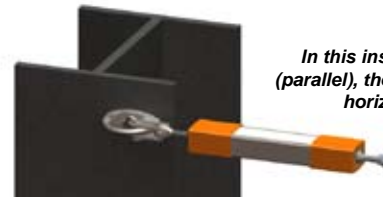

Fig. 1a

In this installation configuration (parallel), the D-bolt must be mounted horizontally as shown.

WARNING: When the D-bolts are being installed parallel or alongside the horizontal lifeline (see Fig. 1a), the D-bolts must be mounted horizontally. D-bolts being installed perpendicular to the lifeline (see Fig. 1b) may be mounted at any angle.



Fig. 1b

In this installation configuration (perpendicular), the D-bolt may be mounted horizontally, vertically or at any angle.

WARNING: On D-bolts installed to W-Shaped beams (see Fig. 1c), the mounting hole must be drilled perpendicular to the flange. D-bolts installed to S-Shaped beams (see Fig. 1d) must be drilled perpendicular to the flange and a tapered (aka bevel, side hill or wedge) washer must be used to ensure the D-bolt and/or nut and washer seats squarely against the beam surface.

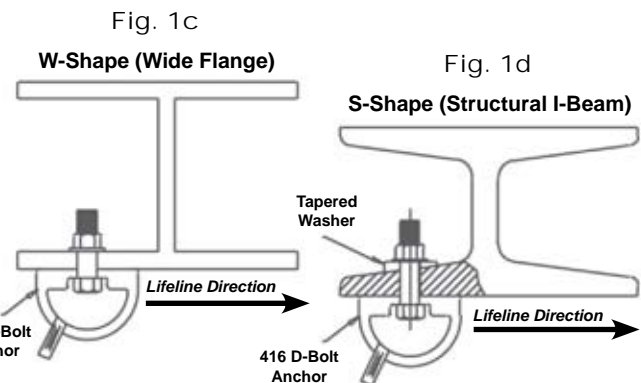

Fig. 1c

Fig. 1d

3. Mount the D-Bolt Anchor by passing the approved 5/8" (16mm) stainless steel bolt through the hole in the connector and through the hole in the structure (see Fig. 1). Attach the lockwasher and nut. Completely tighten making sure the entire nut is engaged on the threads and the device is securely fastened to the structure. Torque to 125 ft. lbs. (169Nm).

WARNING: Do not overtighten. Excessive tension can cause damage to the anchorage system. Use recommended torque value above.

Repeat these procedures to install D-bolt anchor on opposite end of lifeline system.

4.2 Installation of Universal Intermediate Brackets (Required for Multiple-Span Systems only)

The intermediate brackets are designed to allow free-floating or fixed positioning. Most often free-floating positioning is desired. However, fixed positioning may be needed in the case of an obstacle which may interfere with the lifeline.

To install intermediate brackets, follow the instructions below:

1. Install the intermediate support clevis to the beam or structure using the included hardware. Torque to 69 ft. lbs. (94Nm).
2. Attach the cable support according to the desired result.

Free-Floating Positioning (see Fig. 2a): To allow the cable support to float freely, align the star-shaped hole in the clevis with the circle hole in the cable support and insert the bolt completely through the aligned holes. (NOTE: The bolt must enter through the side with the star hole.) Attach the washer and nut.

Fixed Positioning (see Fig. 2b): To fix the position of the cable support, align the star-shaped hole in the clevis with the square hole in the cable support and angle the support in the desired fixed position. Insert the bolt completely through the aligned holes. (NOTE: The bolt must enter through the side with the star hole.) Attach the washer and nut.

3. Slide the plastic cable guides into position in the cable support and snap into place. The cable support is now ready to receive the cable.

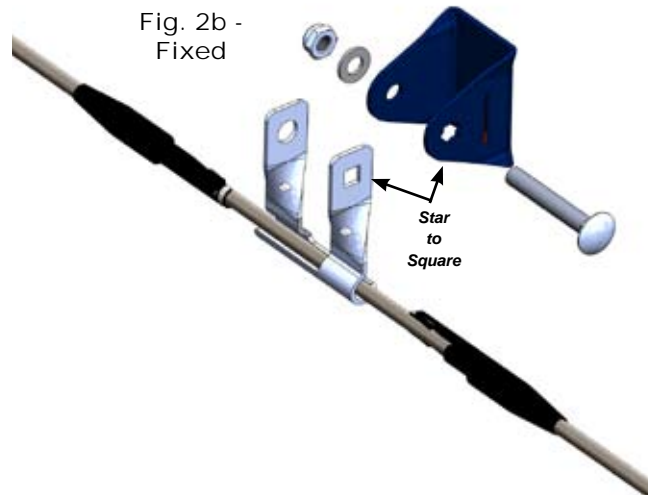
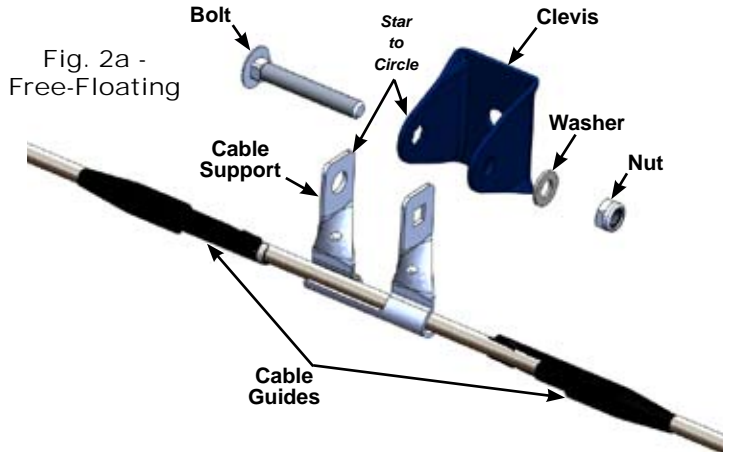

To replace intermediate brackets without disassembling or replacing the lifeline, follow the instructions below:

1. Using a flat tipped screwdriver, unclip the plastic cable guides. Slide the cable guides aside. Then open each cable guide enough to clear the cable and remove.
2. Disassemble the cable support from the clevis by removing the nut, washer and bolt. Then turn the cable support such that the cable can be released.
3. Uninstall the clevis from the beam or structure.
4. Install the clevis of the new intermediate bracket to the beam or structure following step 1 of the installation instructions.
5. While aligning the cable within the cable support, attach the cable support by following step 2 of the installation instructions.
6. Add the plastic cable guides to the cable. Slide the cable guides into position in the cable support and snap them into place.

4.3 Installation of Horizontal Lifeline Assembly

WARNING: Always wear gloves when inspecting or installing a cable lifeline.

****Procedures A through C apply to the assembly required on one end of the lifeline.**

A. Multi-Purpose Inline Shock Absorber to D-Bolt Anchor *(see Figure 3)*

In order to allow for maximum take-up and proper tensioning of the lifeline at the end of installation, the shock absorber must be prepared for installation by following the procedure below.

Preparing the Shock Absorber for Installation:

- ▶ Open the shock absorber fully by loosening the locknuts on either side of the shock absorber body and rotating the shock absorber, thus exposing the jaw bolt and eyebolt threads. [Note: When fully open, the shock absorber will measure approximately 22-1/2" (572mm) from end of jaw to end of eyebolt. The shock absorber is designed to allow approximately 4" (102mm) of take-up in the lifeline.]
- ▶ Once the shock absorber is fully open, rotate it in the opposite direction two to three turns. [Note: This allows for the possibility of a lifeline that may be too tight after installation and consequently over-tensioned.]
- ▶ Now proceed with the installation steps below.

1. Remove cotter pin and bolt from shock absorber jaw.
2. Position jaw over D-bolt anchor and insert bolt completely through jaw and anchor.
3. Insert the cotter pin into the end of the bolt.

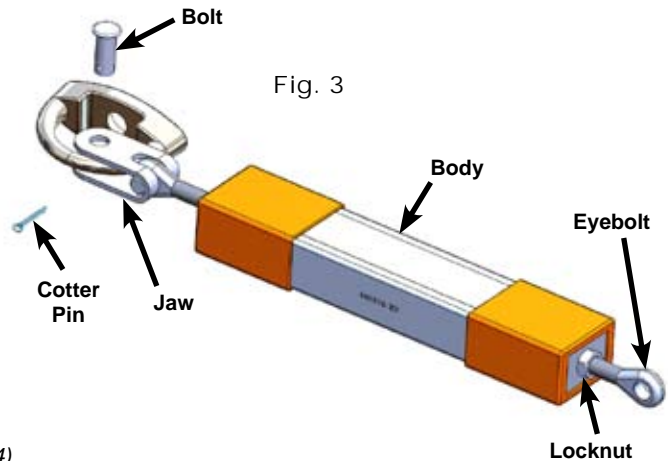

B. Cable to Fast Attach Cable Fitting *(see Figure 4)*

1. Disassemble the fitting and verify components.
2. Slide the cone, wedge set and washer onto the cable end.
3. Then slide the cone over the wedge set and washer. (Note: There should be approximately 1/4" (6mm) of cable showing beyond the washer.)
4. Screw the jaw anchor head into the cone.
5. Tighten the jam nut down onto the cone. Torque to approximately 20 ft. lbs. (27Nm).

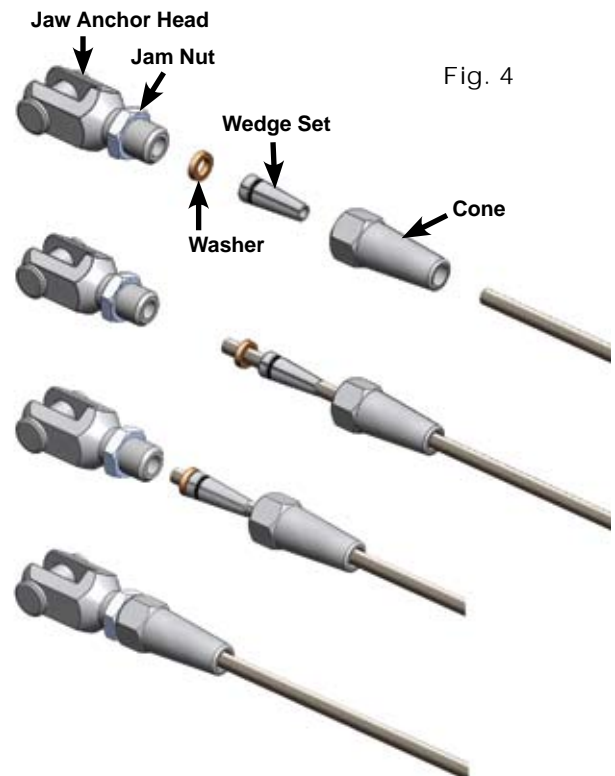

C. Swageless Cable Fitting to Inline Shock Absorber *(see Figure 5)*

1. Remove cotter pin and bolt from jaw anchor head of cable fitting.
2. Align the holes in the jaw head with the shock absorber eyebolt hole, and insert bolt completely through jaw head and eyebolt.
3. Insert the cotter pin into the end of the bolt.

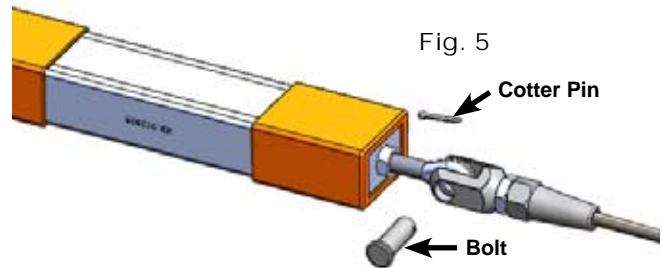

****Procedures D and E apply to the assembly required on the opposite lifeline end. Note: For multiple-span systems, it is recommended to feed cable through intermediate supports before proceeding with the following steps.**

D. Cable Lifeline to Thimble Cable Fitting securing with Cable Clips *(see Figure 6)*

Before cutting the cable, be sure to take into consideration whether the thimble fitting will be connected directly to the D-bolt anchor using an anchor shackle or whether an additional shock absorber must be installed between the components. If an additional shock absorber is needed, it should be installed before cutting the cable and securing the thimble cable fitting (see 4.5 Installation of a Second Shock Absorber).

1. Feed cable around thimble, taking up as much slack in the lifeline as possible. Ensure that there is at least 8-1/2" (216mm) of turnback. Cut excess cable.
NOTE: Allow sufficient lifeline to enable attachment of the thimble to the D-bolt anchor using an anchor shackle.
2. Attach first cable clip as close to the thimble as possible, noting that the U-clip must be installed around the cable with the dead end. Attach two additional cable clips, spacing them 3-1/4" (83mm) apart. Torque cable clip nuts to 17 ft. lbs. (23Nm).

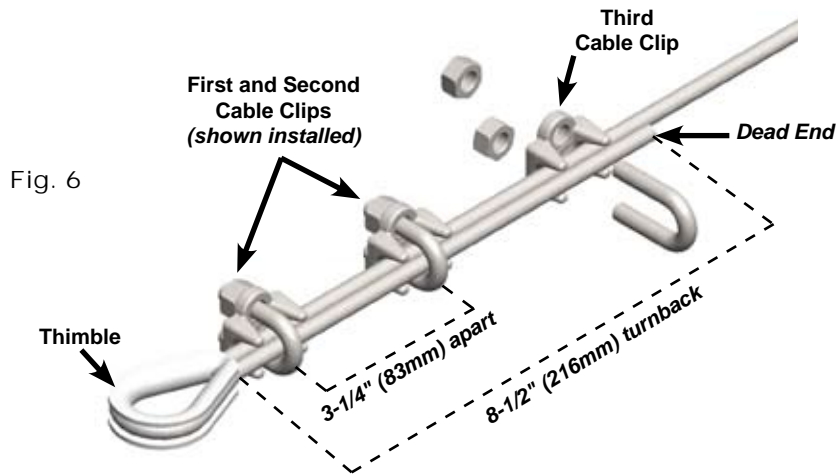

E. Thimble Fitting to D-Bolt Anchor using Anchor Shackle *(see Figure 7)*

1. Remove cotter pin, nut and bolt from anchor shackle.
2. Position anchor shackle through thimble and align the shackle with the D-bolt anchor.
3. Insert bolt completely through shackle and D-bolt anchor, attach nut and tighten snugly using a 3/4" wrench and socket.
4. Insert the cotter pin into the end of the bolt and bend slightly to prevent the pin from backing out.

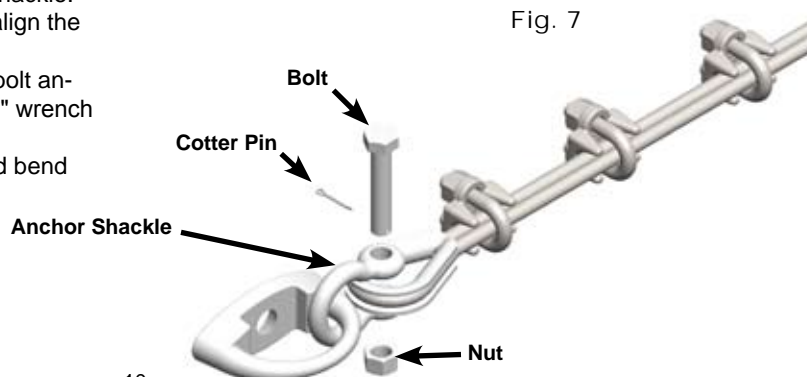

4.4 Tensioning Horizontal Lifeline

IMPORTANT: It is essential that the lifeline be properly tensioned before use. Failure to do so will affect fall clearance requirements and the potential fall forces which may be imposed upon the worker and the system.

1. To prevent the lifeline from twisting while tensioning, use an open end wrench to hold the lifeline while rotating the shock absorber body (drawing the jaw bolt threads and eyebolt threads into the body) until the required tension is achieved. NOTE: The shock absorber is equipped with tension indicators. When the lifeline is properly tensioned, a green ring will be exposed where the shock absorber jaw bolt threads enter and exit the shock absorber body.

WARNING: *If a red ring is exposed, the lifeline is excessively tensioned. In this case, loosen the lifeline by rotating the shock absorber body in the opposite direction.*

IMPORTANT: *In environments in which thermal contraction and expansion can occur, it is important to perform initial lifeline tensioning at peak temperatures. Inspection of the lifeline thereafter should also be done at peak temperatures.*

2. Once the correct tension has been obtained, screw in the locknut on the lifeline side and lock it against the shock absorber body with a 19mm open-end wrench and an 11mm wrench.
3. Proceed in the same way with the locknut on the opposite end of the shock absorber.

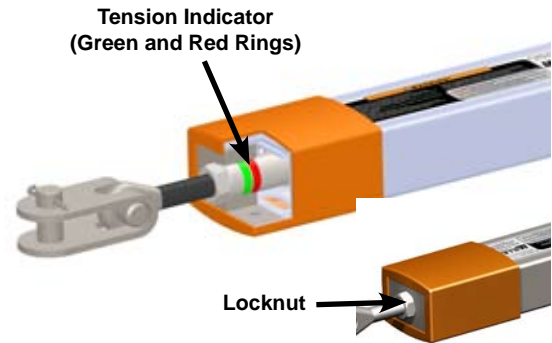

Before using the system, double-check all fasteners to ensure that they are installed correctly and to required specifications.

4.5 Installation of a Second Shock Absorber

1. Follow Procedures A through C of Section 4.3. Before continuing with Procedure D, prepare and install the second shock absorber. See Fig. 9 for order of lifeline components when a second shock absorber is used.
2. Remove cotter pin, nut and bolt from anchor shackle.
3. Position anchor shackle through D-bolt anchor and align the shackle bolt holes with the eyebolt hole on the shock absorber.
4. Insert bolt completely through shackle and shock absorber eyebolt, attach nut and tighten snugly using a 3/4" wrench and socket.
5. Insert the cotter pin into the end of the bolt and bend slightly to prevent the pin from backing out.
6. Follow Procedure D. NOTE: When taking up slack in the lifeline, however, allow sufficient lifeline to enable attachment of the thimble to the shock absorber jaw.
7. Remove cotter pin and bolt from shock absorber jaw.
8. Position jaw over thimble and insert bolt completely through jaw and thimble.
9. Insert the cotter pin into the end of the bolt.

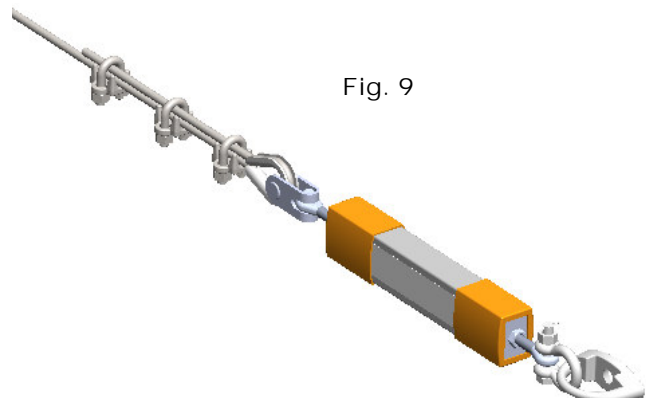

5.0 Operation/Use of Xenon Shuttle on the Horizontal Lifeline

1. Inspect all equipment before use according to the manufacturer's instructions.
2. Properly fit the full-body harness. Refer to the donning instructions provided with the harness.
3. Ensure that the structure being worked on is properly supported before connecting to the horizontal lifeline. Use necessary fall protection equipment while approaching the horizontal lifeline.
4. Install the Xenon Shuttle to the lifeline by pressing and holding the button on the side of the shuttle while pushing in on the attachment ring to open the cable channel jaws. Then insert the shuttle over the lifeline and release.

WARNING: Once installed, ensure that the cable channel jaws are completely closed and locked. When closed and locked, the gap width between the jaws will be between 1/16" (1.6mm) and 5/32" (4mm) maximum without any load being applied.

5. Connect one end of the shock-absorbing lanyard or self-retracting lifeline/fall limiter to the back D-ring of the harness and the other to the attachment ring on the shuttle. Refer to the instructions provided with the connecting device. Ensure that all connections are compatible and that all connectors, such as snap hooks or carabiners, are closed and locked.
6. Proceed along the lifeline. The snap hook (or connector) of the shock-absorbing lanyard or self-retracting lifeline/fall limiter must remain connected to the shuttle and the shuttle to the lifeline at all times along the length of the system. The Xenon Shuttle will self-align to navigate past intermediate brackets.

NOTE: The shuttle should always be removed from the horizontal lifeline after use and cleaned and stored according to 8.0 Inspection and Maintenance.

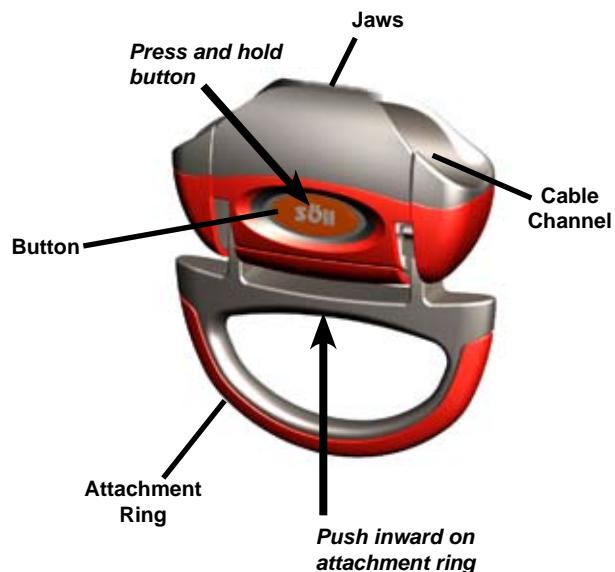

6.0 Fall Clearance

Always know your fall clearance before proceeding with the use of a horizontal lifeline system.

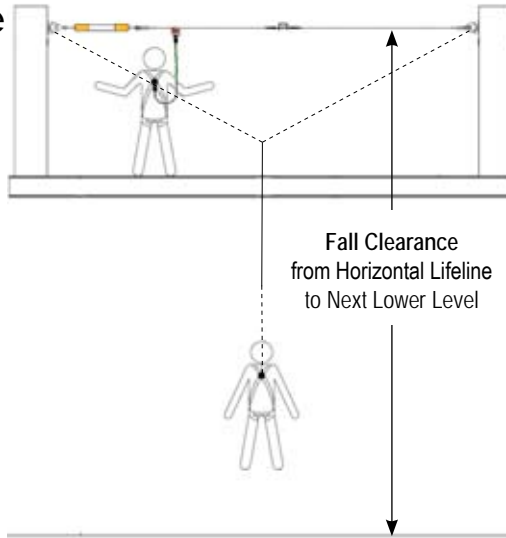

Total Fall Clearance Required* for One to Two Workers when using a Shock-Absorbing Lanyard with a Xenon HLL Single Shock Absorber System

Single-Span Systems				
System/ Span Length** [ft (m)]	Length of Lanyard			
	3ft (.9m)	4ft (1.2m)	5ft (1.5m)	6ft (1.8m)
10 (3m)	14'-7" (4.45m)	15'-7" (4.75m)	16'-7" (5.05m)	17'-7" (5.36m)
15 (4.5m)	15'-1" (4.6m)	16'-1" (4.9m)	17'-1" (5.21m)	18'-1" (5.51m)
20 (6.1m)	15'-6" (4.72m)	16'-6" (5.03m)	17'-6" (5.33m)	18'-6" (5.64m)
25 (7.6m)	15'-11" (4.85m)	16'-11" (5.17m)	17'-11" (5.46m)	18'-11" (5.77m)
30 (9.1m)	16'-3½" (4.97m)	17'-3½" (5.27m)	18'-3½" (5.58m)	19'-3½" (5.88m)

Multiple-Span Systems (with 30 ft. spans)				
System Length** [ft (m)]	Length of Lanyard			
	3ft (.9m)	4ft (1.2m)	5ft (1.5m)	6ft (1.8m)
30 (9.1m)	16'-3½" (4.97m)	17'-3½" (5.27m)	18'-3½" (5.58m)	19'-3½" (5.88m)
60 (18.2m)	16'-6½" (5.04m)	17'-6½" (5.35m)	18'-6½" (5.65m)	19'-6½" (5.96m)
90 (27.4m)	16'-9" (5.11m)	17'-9" (5.41m)	18'-9" (5.72m)	19'-9" (6.02m)
120 (36.5m)	16'-11½" (5.17m)	17'-11½" (5.48m)	18'-11½" (5.78m)	19'-11½" (6.08m)
150 (45.7m)	17'-1½" (5.22m)	18'-1½" (5.53m)	19'-1½" (5.83m)	20'-1½" (6.13m)
180 (54.8m)	17'-3½" (5.27m)	18'-3½" (5.58m)	19'-3½" (5.88m)	20'-3½" (6.19m)
210 (64m)	17'-5" (5.31m)	18'-5" (5.61m)	19'-5" (5.92m)	20'-5" (6.22m)
240 (73.1m)	17'-7" (5.36m)	18'-7" (5.66m)	19'-7" (5.97m)	20'-7" (6.27m)
270 (82.2m)	17'-8½" (5.4m)	18'-8½" (5.7m)	19'-8½" (6.01m)	20'-8½" (6.31m)
300 (91.4m)	17'-10" (5.44m)	18'-10" (5.74m)	19'-10" (6.05m)	20'-10" (6.35m)
330 (100.5m)	17'-11½" (5.47m)	18'-11½" (5.78m)	19'-11½" (6.08m)	20'-11½" (6.39m)
360 (109.7m)	18'-1" (5.51m)	19'-1" (5.82m)	20'-1" (6.12m)	21'-1" (6.43m)
390 (118.8m)	18'-2" (5.54m)	19'-2" (5.84m)	20'-2" (6.15m)	21'-2" (6.45m)
420 (128m)	18'-3½" (5.58m)	19'-3½" (5.88m)	20'-3½" (6.19m)	21'-3½" (6.49m)
450 (137.1m)	18'-4½" (5.6m)	19'-4½" (5.91m)	20'-4½" (6.21m)	21'-4½" (6.52m)
480 (146.3m)	18'-6" (5.64m)	19'-6" (5.94m)	20'-6" (6.25m)	21'-6" (6.55m)
510 (155.4m)	18'-7" (5.66m)	19'-7" (5.97m)	20'-7" (6.27m)	21'-7" (6.58m)

Total Fall Clearance Required* for Three to Four Workers when using a Shock-Absorbing Lanyard with a Xenon HLL Double Shock Absorber System

Single-Span Systems				
System/ Span Length** [ft (m)]	Length of Lanyard			
	3ft (.9m)	4ft (1.2m)	5ft (1.5m)	6ft (1.8m)
10 (3m)	15'-5" (4.7m)	16'-5" (5m)	17'-5" (5.31m)	18'-5" (5.61m)
15 (4.5m)	16'-1" (4.9m)	17'-1" (5.21m)	18'-1" (5.51m)	19'-1" (5.82m)
20 (6.1m)	16'-7½" (5.07m)	17'-7½" (5.37m)	18'-7½" (5.68m)	19'-7½" (5.98m)
25 (7.6m)	17'-2" (5.23m)	18'-2" (5.54m)	19'-2" (5.84m)	20'-2" (6.15m)
30 (9.1m)	17'-8" (5.39m)	18'-8" (5.69m)	19'-8" (5.99m)	20'-8" (6.3m)

Multiple-Span Systems (with 30 ft. spans)				
System Length** [ft (m)]	Length of Lanyard			
	3ft (.9m)	4ft (1.2m)	5ft (1.5m)	6ft (1.8m)
30 (9.1m)	17'-8" (5.39m)	18'-8" (5.69m)	19'-8" (5.99m)	20'-8" (6.3m)
60 (18.2m)	17'-10½" (5.45m)	18'-10½" (5.75m)	19'-10½" (6.06m)	20'-10½" (6.36m)
90 (27.4m)	18'-1" (5.51m)	19'-1" (5.82m)	20'-1" (6.12m)	21'-1" (6.43m)
120 (36.5m)	18'-3" (5.56m)	19'-3" (5.87m)	20'-3" (6.17m)	21'-3" (6.48m)
150 (45.7m)	18'-5" (5.61m)	19'-5" (5.92m)	20'-5" (6.22m)	21'-5" (6.53m)
180 (54.8m)	18'-7" (5.66m)	19'-7" (5.97m)	20'-7" (6.27m)	21'-7" (6.58m)
210 (64m)	18'-9" (5.72m)	19'-9" (6.02m)	20'-9" (6.32m)	21'-9" (6.63m)
240 (73.1m)	18'-11" (5.77m)	19'-11" (6.07m)	20'-11" (6.38m)	21'-11" (6.68m)
270 (82.2m)	19'-½" (5.8m)	20'-½" (6.11m)	21'-½" (6.41m)	22'-½" (6.72m)
300 (91.4m)	19'-2" (5.84m)	20'-2" (6.15m)	21'-2" (6.45m)	22'-2" (6.76m)
330 (100.5m)	19'-3½" (5.88m)	20'-3½" (6.19m)	21'-3½" (6.49m)	22'-3½" (6.79m)
360 (109.7m)	19'-5" (5.92m)	20'-5" (6.22m)	21'-5" (6.52m)	22'-5" (6.83m)
390 (118.8m)	19'-6½" (5.96m)	20'-6½" (6.26m)	21'-6½" (6.57m)	22'-6½" (6.87m)
420 (128m)	19'-8" (5.99m)	20'-8" (6.3m)	21'-8" (6.6m)	22'-8" (6.91m)
450 (137.1m)	19'-9" (6.02m)	20'-9" (6.32m)	21'-9" (6.63m)	22'-9" (6.93m)
480 (146.3m)	19'-10½" (6.06m)	20'-10½" (6.36m)	21'-10½" (6.67m)	22'-10½" (6.97m)
510 (155.4m)	20' (6.1m)	21' (6.4m)	22' (6.71m)	23' (7.01m)

* It is essential to read and understand all information and warnings contained herein regarding fall clearance, the formulas used for determining fall clearance required, and any special assumptions or provisions with regard to the calculations provided.

Shock-Absorbing Lanyard Fall Clearance:

Fall clearance requirements when using a shock-absorbing lanyard are taken from the horizontal lifeline to the next lower level below the work surface.

Fall clearance calculations are based on the length and deflection of the lifeline, the length of the lanyard being used, a 3-1/2 ft. (1.07m) maximum deceleration distance, the number of workers connected to the system, and an average worker height of 6 ft. (1.8m).

~ IMPORTANT ~
Miller Fall Protection
always recommends that
a 3 ft. (.9m) safety factor
be added to all
fall clearance calculations
provided in these tables.

If, in your particular application, there is not adequate fall clearance to ensure maximum worker safety, contact Miller Technical Services to discuss your options. Any variations to the horizontal lifeline system must be approved by Miller Fall Protection.

*****For lifeline spans between the span lengths listed in the fall clearance charts, use the next higher lifeline span calculations. Example: For a 70 ft. lifeline, use the 90 ft. fall clearance calculations.***

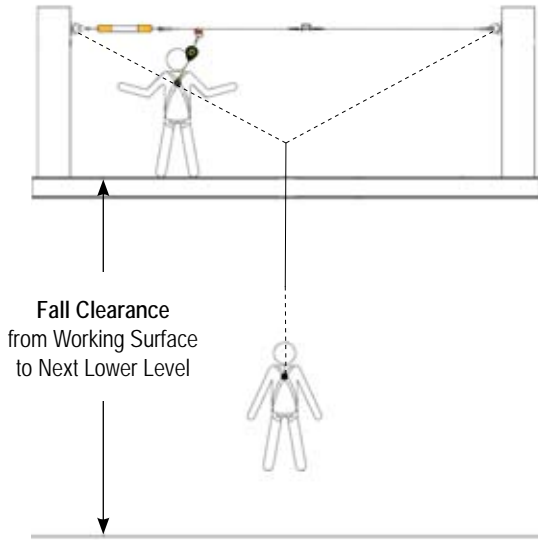

Self-Retracting Lifeline/Fall Limiter Fall Clearance:

Fall clearance requirements when using a self-retracting lifeline (SRL) or fall limiter are taken from the working surface to the next lower level.

Fall clearance calculations are based on the length and deflection of the lifeline, a 3-1/2 ft. (1.07m) maximum Miller SRL/fall limiter fall arrest distance, and the number of workers connected to the system. The SRL/fall limiter calculations assume the worker is standing upright and is located directly adjacent to the horizontal lifeline with the SRL/fall limiter directly overhead and above the level of the harness attachment point. Working away from the point of attachment or crouching to perform work increases the amount of fall clearance required. All of these factors must be carefully considered to ensure that there is adequate fall clearance.

~IMPORTANT~
Miller Fall Protection
always recommends that
a 3 ft. (.9m) safety factor
be added to all
fall clearance calculations
provided in these tables.

If, in your particular application, there is not adequate fall clearance to ensure maximum worker safety, contact Miller Technical Services to discuss your options. Any variations to the horizontal lifeline system must be approved by Miller Fall Protection.

Total Fall Clearance Required* for One to Two Workers and Three to Four Workers when using a Self-Retracting Lifeline/Fall Limiter with a Xenon HLL System		
Single-Span Systems		
System/ Span Length** [ft (m)]	Single Shock Absorber System for 1-2 Workers	Double Shock Absorber System for 3-4 Workers
10 (3m)	9'-7" (2.92m)	10'-5" (3.18m)
15 (4.5m)	10'-1" (3.07m)	11'-1" (3.38m)
20 (6.1m)	10'-6" (3.2m)	11'-7½" (3.55m)
25 (7.6m)	10'-11" (3.33m)	12'-2" (3.71m)
30 (9.1m)	11'-3½" (3.44m)	12'-8" (3.86m)
Multiple-Span Systems (with 30 ft. spans)		
System Length [ft (m)]	Single Shock Absorber System for 1-2 Workers	Double Shock Absorber System for 3-4 Workers
30 (9.1m)	11'-3½" (3.44m)	12'-8" (3.86m)
60 (18.2m)	11'-6½" (3.52m)	12'-10½" (3.93m)
90 (27.4m)	11'-9" (3.58m)	13'-1" (3.99m)
120 (36.5m)	11'-11½" (3.65m)	13'-3" (4.04m)
150 (45.7m)	12'-1½" (3.7m)	13'-5" (4.09m)
180 (54.8m)	12'-3½" (3.75m)	13'-7" (4.14m)
210 (64m)	12'-5" (3.79m)	13'-9" (4.19m)
240 (73.1m)	12'-7" (3.83m)	13'-11" (4.24m)
270 (82.2m)	12'-8½" (3.87m)	14'-½" (4.28m)
300 (91.4m)	12'-10" (3.91m)	14'-2" (4.32m)
330 (100.5m)	12'-11½" (3.95m)	14'-3½" (4.36m)
360 (109.7m)	13'-1" (3.99m)	14'-5" (4.4m)
390 (118.8m)	13'-2" (4.01m)	14'-6½" (4.43m)
420 (128m)	13'-3½" (4.05m)	14'-8" (4.47m)
450 (137.1m)	13'-4½" (4.08m)	14'-9" (4.5m)
480 (146.3m)	13'-6" (4.12m)	14'-10½" (4.54m)
510 (155.4m)	13'-7" (4.14m)	15' (4.57m)

**For lifeline spans between the span lengths listed in the fall clearance charts, use the next higher lifeline span calculations. Example: For a 70 ft. lifeline, use the 90 ft. fall clearance calculations.

7.0 Training

It is the responsibility of the user and the purchaser of this equipment to assure they are familiar with these instructions and are trained in the proper use, installation, operation, maintenance and limitations of this product. Training should be conducted periodically and without exposing the trainee to a fall hazard.

Training is an integral part of our Total Solution in fall protection, since no fall protection equipment – regardless of how effective – can save an employee who is not trained in its use. To meet this crucial requirement, Miller Training provides the knowledge and skills necessary to achieve a safe, more productive work environment. For more information on Miller Training, contact a representative today: 800.873.5242.

8.0 Inspection and Maintenance

Inspection

The Xenon Horizontal Lifeline Kit is designed for today's rugged work environments. To maintain its service life and high performance, all components should be inspected frequently. Visually inspect before each use. Regular inspection by a competent person for wear, damage or corrosion should be a part of your safety program. **Replace equipment if any of the defective conditions explained in this manual are found.**

Before each use, visually and functionally inspect for the following:

- Inspect all components for physical damages, deformation, cracks, wear and corrosion.
- Inspect for crimped fittings, cracks or any signs of loading.
- Inspect the cable lifeline for cuts, frays, kinks, broken strands or other signs of unusual wearing patterns.

[CAUTION: Always wear gloves when inspecting wire rope!]

- Inspect for malfunctioning or missing components. [For replacement parts call: 800.873.5242]
- Check cable tension per section 4.4 Tensioning Horizontal Lifeline.
- Inspect shock absorber to ensure that the red label "STOP" fall indicator is not exposed.
- Inspect Xenon shuttle for physical damages, deformation, cracks, wear and corrosion. Ensure that the shuttle and its parts are functioning properly. The attachment ring should move freely, the button should depress and release to its original position, and the cable channel jaws must close and lock. Refer to section 5.0 Operation/Use of Xenon Shuttle.
- Inspect the personal fall arrest system according to the manufacturer's instructions.

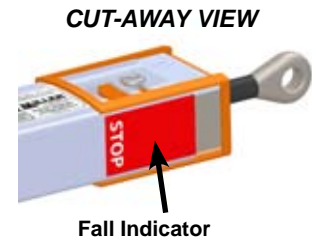

Cleaning and Storage

Basic care of all Miller Fall Protection equipment will prolong the life of the unit and will contribute toward the performance of its vital safety function. Proper storage and maintenance after use are as important as cleansing the equipment of dirt, corrosives, or contaminants. Clean system components using a cloth dampened with water and mild soap or detergent and towel dry. Store components, such as the shuttle, in an area that is clean, dry and free of exposure to fumes or corrosive elements.

Servicing

Servicing must only be carried out by a qualified person. A record log of all servicing and inspection dates for this system should be maintained. **This system and all components must be withdrawn from service if subjected to fall arresting forces.** Only original Miller Fall Protection replacement parts are approved for use in this system. Contact your Miller Fall Protection distributor or Miller Technical Services at 800.873.5242 if you have any questions.

Labels

WARNING!		<p>Max. Capacity: 2 workers [310 lbs. (140.6kg) each] for 1 shock absorber system; 4 workers [310 lbs. (140.6kg) each] for 2 shock absorber system. Meets OSHA and ANSI A10.32-2004</p> <p>MILLER by SPERIAN</p> <p>Sperian Fall Protection, Inc. P.O. Box 271, 1345 15th Street Franklin, PA 16323 USA TOLL FREE 800-873-5242 LB1058 Rev A</p>
<ul style="list-style-type: none"> • Only trained personnel are permitted to use this system. • Inspect before each use according to manufacturer's instructions. • If the system is subjected to fall arrest forces or if inspection reveals an unsafe condition, it must be taken out of service. • A rescue plan, and the means to implement it, must be in place when using this equipment. • This shock absorber may only be used for Miller approved Horizontal Lifeline Systems. • System must not be altered in any way. • Use caution when working in or near hazardous environments. Equipment must not be exposed to chemical, electrical or thermal sources which may affect the integrity of the system. 	<ul style="list-style-type: none"> • Personal fall protection—a full-body harness and shock-absorbing lanyard or self-retracting lifeline, which limits maximum fall arrest forces to 900lb. (4kN)—must be used with this system. • Ensure that there is adequate fall clearance per instruction manual. • Ensure that there is adequate end anchorage and intermediate anchorage strength per instruction manual. <p>WARNING: Manufacturer's instructions supplied with this product at the time of shipment must be followed. Failure to do so may result in serious injury or death. Contact Miller Fall Protection if instruction manual is needed.</p> <p>ADVERTENCIA: Deben seguirse las instrucciones del fabricante provistas con este producto al momento de despacho. El no hacerlo puede resultar en lesiones graves o la muerte. Si se requiere el manual de instrucciones consulte con Miller Fall Protection.</p> <p>AVERTISSEMENT: Vous devez respecter les instructions du fabricant que vous avez reçues avec le produit. Dans le cas contraire, vous risquez de blessures graves ou même la mort. Contactez Miller Fall Protection si vous avez besoin d'un nouveau manuel.</p>	

Inspection and Maintenance Log

Registre D'inspection et D'entretien

Registro de Inspección y Mantenimiento

DATE OF MANUFACTURE: _____
 DATE DE FABRICATION / FECHA DE FABRICACIÓN

MODEL NUMBER: _____
 NUMÉRO DE MODÈLE / NÚM. DE MODELO

DATE PURCHASED: _____
 DATE D'ACHAT / FECHA DE COMPRA

INSPECTION DATE DATE D'INSPECTION FECHA DE INSPECCIÓN	INSPECTION ITEMS NOTED POINTS NOTÉS LORS DE L'INSPECTION PUNTOS DE INSPECCIÓN RELEVANTES	CORRECTIVE ACTION ACTION CORRECTIVE MEDIDA CORRECTIVA	MAINTENANCE PERFORMED ENTRETIEN EFFECTUÉ MANTENIMIENTO REALIZADO
Approved by: Approuvé par: Aprobado por:			
Approved by: Approuvé par: Aprobado por:			
Approved by: Approuvé par: Aprobado por:			
Approved by: Approuvé par: Aprobado por:			
Approved by: Approuvé par: Aprobado por:			
Approved by: Approuvé par: Aprobado por:			
Approved by: Approuvé par: Aprobado por:			
Approved by: Approuvé par: Aprobado por:			
Approved by: Approuvé par: Aprobado por:			



MILLER® FALL PROTECTION PRODUCTS
TOTAL SATISFACTION ASSURANCE

At Miller Fall Protection, we have been providing quality Miller brand fall protection equipment to millions of workers worldwide since 1945.

LIMITED LIFETIME WARRANTY
BACKED BY OVER 60 YEARS IN THE FALL PROTECTION BUSINESS

We sincerely believe that our fall protection equipment is the best in the world. Our products endure rigorous tests to ensure that the fall protection equipment you trust is manufactured to the highest standards. Miller fall protection products are tested to withstand normal wear and tear, but are not indestructible and can be damaged by misuse. Our Limited Lifetime Warranty does not apply to normal wear and tear or abusive treatment of the product.

In the unlikely event that you should discover defects in either workmanship or materials, under our Limited Lifetime Warranty, we will repair or replace the product at our expense. If a replacement is necessary and your product is no longer available, a comparable product will be substituted. Should a product issue surface, contact us at 800.873.5242.

Manufacturing specifications are subject to change without notice.

PRODUITS MILLER® FALL PROTECTION
ASSURANCE DE SATISFACTION TOTALE

Chez Miller Fall Protection, nous fournissons des équipements de protection contre les chutes de marque Miller de qualité à des millions de travailleurs dans le monde entier depuis 1945.

GARANTIE LIMITÉE À VIE
ASSURÉE GRÂCE À PLUS DE 60 ANS PASSÉS DANS LE DOMAINE DE LA PROTECTION CONTRE LES CHUTES

Nous croyons sincèrement que notre équipement de protection contre les chutes est le meilleur au monde. Nos produits sont soumis à des tests rigoureux, afin d'assurer que les équipements de protection contre les chutes dans lesquels vous avez confiance sont fabriqués selon les normes les plus exigeantes. Les produits de protection contre les chutes Miller sont soumis à des essais pour vérifier qu'ils résistent à une usure normale; ils ne sont cependant pas indestructibles et peuvent s'endommager en cas de mauvaise utilisation. Notre garantie limitée à vie ne s'applique pas à l'usure normale ou à un usage abusif du produit.

Dans le cas peu probable où vous découvririez des défauts, soit de fabrication, soit de matériau, dans le cadre de notre garantie à vie, nous réparerons ou remplacerons le produit à nos frais. En cas de remplacement, si votre produit n'est plus offert, vous recevrez un produit comparable. En cas de problème sur un produit, nous contacter au 800-873-5242.

Les caractéristiques de fabrication peuvent être modifiées sans préavis.

PRODUCTOS ANTICAÍDAS MILLER®
GARANTÍA DE SATISFACCIÓN TOTAL

En Miller Fall Protection, venimos suministrando desde 1945 los equipos de protección anticaídas con la calidad Miller a millones de trabajadores en todo el mundo.

GARANTÍA LIMITADA DE POR VIDA
NOS RESPALDAN MÁS DE 60 AÑOS EN LA FABRICACIÓN DE EQUIPO ANTICAÍDAS

Sinceramente creemos que su equipo de protección contra caídas es el mejor del mundo. Nuestros productos resisten rigurosas pruebas para garantizar que el equipo de protección contra caídas en el que usted confía está fabricado de conformidad con las normas más elevadas. Los productos anticaídas Miller son sometidos a pruebas para que resistan el desgaste normal, pero no son indestructibles y su incorrecta utilización puede dañarlos. Nuestra Garantía limitada de por vida no se aplica al desgaste normal ni al maltrato del producto.

En el poco probable caso de que usted descubriera defectos de mano de obra o materiales, por nuestra Garantía limitada de por vida, repararemos o sustituiremos el producto por cuenta nuestra. Si un reemplazo es necesario y nuestro producto ya no está disponible, se lo sustituiremos por otro comparable.

En caso de que surja un problema con el producto, contáctenos al 800.873.5242.

Las especificaciones de fabricación están sujetas a modificaciones sin previo aviso.



Toll Free: 800.873.5242
Fax: 800.892.4078

Download this manual at: www.millerfallprotection.com
Téléchargez ce manuel à l'adresse: www.millerfallprotection.com
Puede bajar por Internet este manual en: www.millerfallprotection.com

Sperian Fall Protection, Inc.
P.O. Box 271, 1345 15th Street
Franklin, PA 16323 USA