

**GRAVITY[®]
KILLS**

DEFY IT!

Innovative Fall Protection Solutions
with Safety & Comfort in Mind.

MILLER[®]

Meet
**MILLER
REVOLUTION[™]
HARNESSES**
See inside for details!

Miller... Synonymous with Safety, Quality and Innovation

As the industry leader for more than five decades, Bacou-Dalloz™ provides a comprehensive line of Miller® brand fall protection products and related services.

Product Safety Compliance

- All Miller products are designed and tested by full-time qualified engineers and technicians
- Our in-house testing facility complements independent third-party testing with our participation in the Safety Equipment Institute (SEI) certification program
- Miller fall protection products meet all applicable OSHA, ANSI and CSA requirements and standards. In addition, CE certified products are available. Ask for details.



Quality Manufacturing

- Our facility in Franklin, PA has been designated the fall protection Center of Operational Excellence in the Americas, complementing our global manufacturing network in Hof, Germany, Vierzon, France and Melbourne, Australia
- The Franklin facility is ISO 9001:2000 certified — proving international recognition of our overall design and manufacturing processes.



Product Innovation

New product innovations and industry firsts:

- **Miller Revolution™ Harness**, engineered with seven unique components and more than 11 key product features
- **Miller Scorpion™ Personal Fall Limiter** – an affordable alternative to shock-absorbing lanyards
- **Miller Falcon™ Self-Retracting Lifelines** are designed to be the lightest, most rugged line of composite cable retractables on the market
- **Miller BackBiter® Tie-Back Lanyard with a Miller 5K® Snap Hook** provides an all-in-one anchorage connector and shock-absorbing lanyard

Comprehensive Problem Solving

With our goal of being your comprehensive problem-solving provider, we are committed to meeting your fall protection needs with innovative products and services, including safety audits, training, and hazard identification.

Table of Contents

- 3 Personal Fall Arrest System
- 4 Jobsite Solutions: Personal Fall Arrest System Selections

Body Wear

- 6 Buyer's Guide to Harness Features; How to Don a Harness

New! Miller Revolution Harnesses

- 7 Ultra Harnesses
- 8 DuraFlex Python Harnesses
- 9 DuraFlex Harnesses
- 10 Titan T-Flex Harnesses; Body Belts
- 11 HP (High Performance) Harnesses
- 12 Non-Stretch Harnesses; High-Visibility Vests; Harness Accessories
- 13 Relief Step Safety Device; Rescue Ladder

Utility Products

- 14 DuraFlex Utility Harnesses; StopFall System; Safety Straps
- 15 Linemen's Belts; Rescue Ladder; SideWinder Retractable Lanyard

Connecting Devices

- 16 Manyard II & Manyard HP Lanyards
- 17 Manyard & StretchStop/SofStop Lanyards
- 18 HP Lanyards with SofStops; Lanyards with SofStops
- 19 BackBiter Tie-Back Lanyards; Retractable Web Lanyards; O-Ring Extension Option
- 20 Scorpion Personal Fall Limiters
- 21 Black Rhino Self-Retracting Lifelines
- 22 MiniLite Fall Limiters; Cab Mount Brackets
- 23 Falcon Self-Retracting Lifelines
- 24 MightyLite Self-Retracting Lifelines
- 25 Welding Products
- 26 Positioning & Restraint Lanyards; Positioning Assemblies
- 27 Rope Grabs; Vertical Lifelines

Anchorage Connectors

- 28 Grip Anchorage Connectors
- 29 Temporary Anchorage Connectors
- 30 Permanent Anchorage Connectors
- 31 Edge Fall Protection System; Shadow Beam Anchors

Roofing Products

- 32 Roof Systems

Temporary Lifelines

- 34 SkyWalker Temporary Horizontal Lifelines
- 35 SkyWalker Wire Rope Lifeline Kits; Temporary Horizontal Lifeline Systems

Permanent Lifelines

- 36 Söll Xenon System; Söll GlideLoc Systems
- 37 TranScendor System; Söll PivotLoc System

Confined Space

- 38 MightEvac Self-Retracting Lifelines; ManHandler Hoist/Winch

New! DuraHoist Confined Space Systems

- 39 Tripod; Davit Mounting System; Quad Pod

Rescue/Descent Systems

- 40 Universal Rescue System; Descent Device; SafEscape System
- 41 Miller/Troll Training
- 42 Regulations & Standards
- 43 Fall Clearance Requirements; Tool Lanyards

Miller® Personal Fall Arrest System

Three key components of the Personal Fall Arrest System (PFAS) must be in place and properly used to provide maximum worker protection.



A Anchorage/ Anchorage Connector

Anchorage: Commonly referred to as a tie-off point (Ex: I-beam)

Anchorage Connector: Used to join the connecting device to the anchorage (Ex: cross-arm strap)

B Body Wear

Body Wear: The personal protective equipment worn by the worker (Ex: full-body harness)

C Connecting Device

Connecting Device: The critical link which joins the body wear to the anchorage/anchorage connector (Ex: shock-absorbing lanyard *shown*, or retractable lifeline)

Individually these components will not provide protection from a fall. However, when used properly and in conjunction with each other, they form a Personal Fall Arrest System that becomes vitally important for safety on the jobsite.

Personal Fall Arrest System Selections

Iron Working



Miller Shadow®
Beam Anchor

Anchorage:

- Shadow Beam Anchor** (8816-14) *See pg. 31*
- Adjustable beam anchor
 - Fits flange sizes 3" to 14"
 - Lightweight, high-strength aluminum construction

Body Wear:

- HP Harness** (650T61/UGN) *See pg. 11*
- Non-stretch webbing protected w/Teflon®HT
 - Friction buckle shoulder straps; tongue buckle leg straps
 - Attached back pad w/side D-rings for positioning; adjustable shoulder pads; removable waist belt

Connecting Device:

- Lanyard w/Double Shock-Absorber Pack** (940WLS/6FTGN) *See pg. 31*
- 6 ft. web lanyard w/double SofStop shock-absorber pack for 12 ft. free fall

Positioning Device:

- Chain Assembly** (6756RS) *See pg. 26*
- 13-link chain positioning assembly
 - Swivel attachment; length adjuster

Painting



HP™ Harness

Anchorage:

- Cross-Arm Anchorage Connector Strap** (8183/6FTGN) *See pg. 29*
- 6 ft. web strap

Body Wear:

- HP Harness** (650T/UGN) *See pg. 11*
- Non-stretch webbing protected w/Teflon®HT
 - Friction buckle shoulder straps; mating buckle leg straps

Connecting Device:

- Black Rhino™ Self-Retracting Lifeline** (CFL-4/9FT) *See pg. 21*
- 9 ft. stainless steel wire rope lifeline arrests free falls
 - Quick-activating, high-strength stainless steel braking system
 - Repairable; no annual factory recertification required

Drilling Rig



Oil Rig Harness Combo

Anchorage:

- Cross-Arm Anchorage Connector Strap** (8183/6FTGN) *See pg. 29*
- 6 ft. web strap

Body Wear:

- Oil Rig "Belly Buster" Harness/Saddle Seat Combination** (000217)
- Non-stretch webbing harness
 - Tongue buckle leg straps; permanently-attached waist belt w/2 built-in, triple-action, auto-lock carabiners for rope positioning attachment
 - Built-in saddle seat for raising/lowering

Connecting Device:

- MightyLite Self-Retracting Lifeline** (RL175SS/175FT) *See pg. 24*
- 175 ft., 3/16" stainless steel wire rope
 - Corrosion-resistant stainless steel & aluminum components
 - Sealed braking system; built-in, heavy-duty handle

Concrete Forming



Grip™ Anchor

Anchorage:

- Grip Anchorage Connector** (496) *See pg. 28*
- Portable/reusable concrete anchorage connector
 - Designed for single user

Body Wear:

- DuraFlex Stretchable Harness** (NON-STOCK; E650-61/UGN)
- Stretchable webbing protected w/Teflon®HT
 - Friction buckle shoulder straps; tongue buckle leg straps
 - Attached 6-inch back pad w/side D-rings for positioning; adjustable shoulder pads; removable waist belt

Connecting Device:

- Black Rhino Self-Retracting Lifeline** (CFL-4/9FT) *See pg. 21*
- 9 ft. stainless steel wire rope lifeline arrests free falls
 - Quick-activating, high-strength stainless steel braking system
 - Repairable; no annual factory recertification

Positioning Device:

- Positioning Assembly** (6756RS) *See pg. 26*
- 13-link chain positioning assembly
 - Swivel attachment; length adjuster

Industrial

Anchorage:

Cross-Arm Anchorage Connector Strap
(8183/6FTGN) See pg. 29

- 6 ft. web strap

Body Wear:

DuraFlex® Stretchable Harness
(E650-4/UGN) See pg. 9

- Stretchable webbing protected w/Teflon®HT
- Tongue buckle leg straps

Connecting Device:

Scorpion Personal Fall Limiter
(PFL-4/9FT) See pg. 20

- 9 ft. retractable web lanyard protected w/Teflon®HT arrests free falls
- Dual operation versatility: attach to harness as personal fall limiter or use as traditional retractable lifeline
- Quick-activating, high-strength stainless steel braking system



Scorpion™ PFL

Food Processing

Anchorage:

Cross-Arm Anchorage Connector Strap
(8183/6FTGN) See pg. 29

- 6 ft. web strap

Body Wear:

DuraFlex Python® Ultra Harness
(P950QC/UGN) See pg. 7

- Cushioned and stretchable webbing protected w/Teflon®HT
- Quick-connect buckles on the chest & leg straps
- Comfort-touch back D-ring pad

Connecting Device:

Black Rhino Self-Retracting Lifeline
(CFL-4/9FT) See pg. 21

- 9 ft. stainless steel wire rope lifeline arrests free falls
- Quick-activating, high-strength stainless steel braking system
- Repairable; no annual factory recertification required



Black Rhino™ SRL

Tower Climbing

Anchorage:

Söll GlideLoc Fixed Rail Ladder Climbing System See pg. 36

- Allows for "hands-free" operation; also ideal for closed-cage environments

Body Wear:

DuraFlex Stretchable Harness
(E650-89/UGN) See pg. 9

- Stretchable webbing protected w/Teflon®HT
- Friction buckle shoulder straps; tongue buckle leg straps
- Front D-ring; attached 6-inch back pad w/side D-rings for positioning; 2-inch tool ring; removable waist belt

Connecting Device:

BackBiter® Tie-Back Lanyard
(8798B/6FTGN) See pg. 19

- All-in-one double-leg lanyard w/SofStop shock absorber pack and cross-arm anchorage connectors
- 6 ft. Cordura nylon web lanyard protected w/Teflon®HT
- Two 5K snap hooks withstand gate load capacity from any angle



DuraFlex® Harness

Warehousing

Anchorage:

Cab Mount Bracket (CMB) See pg. 22

- Increases overhead clearance in lift truck cabs
- Heavy-duty steel construction

Body Wear:

DuraFlex Stretchable Harness
(E850-2/UGN) See pg. 9

- Stretchable webbing protected w/Teflon®HT
- Unique back D-ring extension
- Mating buckle leg straps; friction buckle shoulder straps

Connecting Device:

MiniLite Self-Retracting Lifeline
(FL11-0/11FT) See pg. 22

- 11 ft. self-retracting lanyard
- Lightweight, compact design
- Quick-activating, high-strength stainless steel braking system
- High impact-resistant housing
- Webbing protected w/Teflon®HT



Miller MiniLite®
Cab Mount Bracket

Additional Industry-Specific Fall Protection Equipment:

Welding - page 25

Utility - page 14

Roofing - pages 32 & 33

Buyer's Guide To Harness Features



Standard Features



Sliding Back D-Ring

Sliding back D-ring with injection-molded, flexible Santoprene® D-ring pad. Comfort-touch back D-ring pad (inset) provides added comfort.



Pull-Free Lanyard Rings

Allows user to attach lanyard when not in use. Minimizes hazards associated with the lanyard hanging freely.

D-Ring Options



Front D-Ring

Used for a variety of climbing, confined space and rescue applications.



Side D-Rings

Most commonly used for work positioning.



Shoulder D-Rings

Primarily used for lifting and lowering individuals, such as in confined space and rescue applications.

Adjustment Buckle Types



Friction Buckle

To adjust the friction buckle, simply pass the webbing over the knurled bar and back down between the knurled bar and frame. Pull web end to tighten.



Mating Buckle

To connect the mating buckle, push the center bar buckle completely through the square link and allow it to fall into place. Pull web end to tighten.



Tongue Buckle

The tongue buckle works similar to a belt buckle. Insert the loose strap of webbing through the buckle tongue through the appropriate grommet hole. Push remaining webbing through the keeper.



Quick-Connect Buckle

Quick-Connect Buckles for chest and leg straps interlock similar to a seat belt for easy donning and feature a dual-tab release mechanism to prevent accidental opening.



Relief Step™ Safety Device

Small and lightweight; the Relief Step Safety Device attaches to any brand full-body harness.

6 Easy Steps That Could Save Your Life

How To Don A Harness



Step 1

Hold harness by back D-ring. Shake harness to allow straps to fall in place.



Step 2

If chest, leg and/or waist straps are buckled, release straps and unbuckle at this time.



Step 3

Slip straps over shoulders so **D-ring is located in middle of back between shoulder blades.**



Step 4

Pull leg straps between legs and connect to opposite end. Repeat with second leg strap. If belted harness, connect waist strap after leg straps.



Step 5

Connect chest strap and position in midchest area. Tighten to keep shoulder straps taut.

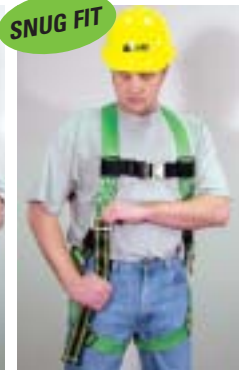

Step 6

After all straps have been buckled, **tighten all buckles so that harness fits snug but allows full range of movement.** Pass excess strap through loop keepers.

SNUG FIT

New!

MILLER REVOLUTION™ HARNESS

ENGINEERED WITH 7 UNIQUE COMPONENTS
AND MORE THAN 11 KEY PRODUCT FEATURES

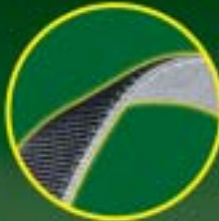

DUALTECH™ WEBBING

Donning made easy with two-sided, contrasting color webbing and textures



WEB FINIAL

Clip-on design safely organizes webbing after proper adjustment



CAM BUCKLE

Easy, one-hand adjustment/release allows simultaneous adjustment of shoulder straps



PIVOTLINK™ CONNECTION

Unique rotary design provides greater comfort in bending/mobility



SELF-CONTAINED LABEL PACK

Integrated pack encapsulates labels minimizing damage and loss



ERGOARMOR™ BACK SHIELD

Semi-flexible back shield minimizes impact from sharp/heavy snap hooks and self-retracting lifelines



ATTACHMENT POINTS FOR INTEGRATED ACCESSORY SYSTEM

Modular attachment design provides connection points for belts/tools/accessories

THE TURNING POINT

IN FALL PROTECTION TECHNOLOGY

MILLER REVOLUTION HARNESSES & ACCESSORIES

REVOLUTION HARNESS WITH DUALTECH WEBBING

Model No.	Standard Features	Special Features*
RDT-QC/U		Quick-Connect Buckle Legs
RDT-TB/U	• Quick-Connect Chest Buckles	Tongue Buckle Legs
RDT-QC-B/U	• Cam Buckles	Removable Belt, Quick-Connect Buckle Legs
RDT-TB-B/U	• ErgoArmor Back Shield	Removable Belt, Tongue Buckle Legs
RDT-QC-DP/U	• Stand-Up D-Ring	Side D-Rings & Pad, Quick-Connect Buckle Legs
RDT-TB-DP/U	• Self-Contained Label Pack	Side D-Rings & Pad, Tongue Buckle Legs
RDT-QC-BDP/U	• Web Finales	Removable Belt, Side D-Rings & Pad, Quick-Connect Buckle Legs
RDT-TB-BDP/U		Removable Belt, Side D-Rings & Pad, Tongue Buckle Legs

REVOLUTION HARNESS WITH DURAFLEX® WEBBING

Model No.	Standard Features	Special Features*
RDF-QC/U		Quick-Connect Buckle Legs
RDF-TB/U	• Quick-Connect Chest Buckles	Tongue Buckle Legs
RDF-QC-B/U	• Cam Buckles	Removable Belt, Quick-Connect Buckle Legs
RDF-TB-B/U	• ErgoArmor Back Shield	Removable Belt, Tongue Buckle Legs
RDF-QC-DP/U	• Stand-Up D-Ring	Side D-Rings & Pad, Quick-Connect Buckle Legs
RDF-TB-DP/U	• Self-Contained Label Pack	Side D-Rings & Pad, Tongue Buckle Legs
RDF-QC-BDP/U	• Web Finales	Removable Belt, Side D-Rings & Pad, Quick-Connect Buckle Legs
RDF-TB-BDP/U		Removable Belt, Side D-Rings & Pad, Tongue Buckle Legs

REVOLUTION HARNESS WITH PYTHON® WEBBING

Model No.	Standard Features	Special Features*
RPY-QC/U		Quick-Connect Buckle Legs
RPY-TB/U	• Quick-Connect Chest Buckles	Tongue Buckle Legs
RPY-QC-B/U	• Cam Buckles	Removable Belt, Quick-Connect Buckle Legs
RPY-TB-B/U	• ErgoArmor Back Shield	Removable Belt, Tongue Buckle Legs
RPY-QC-DP/U	• Stand-Up D-Ring	Side D-Rings & Pad, Quick-Connect Buckle Legs
RPY-TB-DP/U	• Self-Contained Label Pack	Side D-Rings & Pad, Tongue Buckle Legs
RPY-QC-BDP/U	• Web Finales	Removable Belt, Side D-Rings & Pad, Quick-Connect Buckle Legs
RPY-TB-BDP/U		Removable Belt, Side D-Rings & Pad, Tongue Buckle Legs

REVOLUTION HARNESS WITH KEVLAR®-NOMEX® WEBBING

Model No.	Standard Features	Special Features*
RKN-QC/U	• Quick-Connect Chest Buckles	• Stand-Up D-Ring Quick-Connect Buckle Legs
RKN-TB/U	• Cam Buckles	• Self-Contained Label Pack Tongue Buckle Legs
RKN-QC-B/U	• ErgoArmor Back Shield	• Web Finales Removable Belt, Quick-Connect Buckle Legs
RKN-TB-B/U		Removable Belt, Tongue Buckle Legs

ACCESSORIES

Model No.	Description
RIA-T1	Mini Cell Phone Holder w/Snap-On Connector
RIA-T2	Regular Cell Phone/Jobsite Radio Holder, w/Snap-On Connector
RIA-T3	Water Bottle Holder, 1 Qt.
RIA-T4	Large Open Bolt & Bull Pin Bag w/Quick-Release Tool Snap
RIA-T5	Medium Open Bolt & Bull Pin Bag
RIA-T6	2 Pocket Nail & Tool Pouch
RIA-T7	Large Multi-Pouch Tool Bag w/2 Steel Hammer Loops
RIA-T8	Padded Hammer Loop
RIA-T9	Open End Pliers & Tool Holder
RIA-T10	Zippered Cylindrical Utility Pouch

OPTIONAL PADDING

RIA-P1	Shoulder/Leg Pads (2 pack)
RIA-P2	Seat Pad

CONNECTION POINTS

RIA-C1	Sliding Belt Accessory Connectors (3 pack)
RIA-C2	Universal Accessory & Belt Attachment Clip (2 pack)

BELTS (Fits sizes 32" to 54")

RIA-B1	Belt with PivotLink Attachments, 5 Accessory Connectors
RIA-B2	Belt w/pad and PivotLink Attachments, 5 Accessory Connectors

IDENTIFICATION KITS

RIA-BL	(10) Blue Self-Adhesive Labels w/Write-In Window
RIA-YL	(10) Yellow Self-Adhesive Labels w/Write-In Window
RIA-RD	(10) Red Self-Adhesive Labels w/Write-In Window
RIA-GN	(10) Green Self-Adhesive Labels w/Write-In Window

ACCESSORY KITS & RIGS (Fits sizes 32" to 54")

Model No.	Description
RIA-K1 (Job Kit 1)	• Mini Cell Phone Holder w/Snap-On Connector • Water Bottle Holder
RIA-K2 (Job Kit 2)	• Regular Cell Phone/Jobsite Radio Holder w/Snap-On Connector • Water Bottle Holder • Large Multi-Pouch Tool Bag w/2 Steel Hammer Loops
RIA-R1 (Tool Rig 1)	• Belt with PivotLink Attachments • 5 Accessory Connectors • Large Multi-Pouch Tool Bag w/2 Steel Hammer Loops • 2 Pocket Nail & Tool Pouch • Zippered Cylindrical Utility Pouch
RIA-R2 (Tool Rig 2)	• Belt w/Pad and PivotLink Attachments • 5 Accessory Connectors • Large Multi-Pouch Tool Bag w/2 Steel Hammer Loops • 2 Pocket Nail & Tool Pouch • Zippered Cylindrical Utility Pouch
RIA-R3 (Tool Rig 3)	• Belt with PivotLink Attachments • 5 Accessory Connectors • 2 Large Open Bolt & Bull Pin Bags • Padded Hammer Loop
RIA-R4 (Tool Rig 4)	• Belt w/Pad and PivotLink Attachments • 5 Accessory Connectors • 2 Large Open Bolt & Bull Pin Bags • Padded Hammer Loop

HARNES SIZING CHART

Model numbers listed are for **Universal** size. Harnesses are also available in **Small/Medium** and **XXL/XXXL** Large, by replacing the "U" in the model number with "S/M" or "XXL/XXXL" (Ex: RDT-QC-B/XXL/XXXL).

For front D-ring vest-style option, add "FD" to the corresponding harness model number (Ex: RDTFD-QC/U).

All Miller brand fall protection products meet applicable OSHA, ANSI and CSA requirements.

Rated to 400 lbs. (181.4kg) capacity.

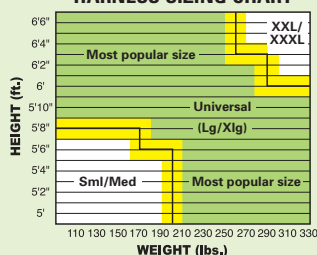

*SPECIAL FEATURES



Removable Belt



Side D-Rings & Pad



Quick-Connect Buckle



Tongue Buckle

This equipment should only be used in conjunction with the manufacturer's instructions. Failure to follow instructions could result in serious injury or fatality.

Miller ULTRA Harnesses

Ultimate Comfort,
Fit and Safety.

A new premier line of Miller® brand harnesses. Easy-to-wear, the new Miller Ultra harnesses provide greater comfort and increased mobility, while improving safety and reducing worker fatigue.

RATED TO 400 lbs.
(181.4kg)
CAPACITY



Sleek Quick-Connect Buckles for chest and leg straps, interlock similar to a seat belt, for easy donning and feature a dual-tab release mechanism to prevent accidental opening.



Comfort-Touch Back D-Ring Pad is designed with a specially-woven, breathable fabric that provides greater comfort; orients harness for quick tangle-free donning.

DuraFlex Python® Ultra Harness



The DuraFlex Python Ultra Harness features **cushioned tubular webbing** in the shoulder straps to minimize possible discomfort around the neck and shoulders when required to wear a tool belt.

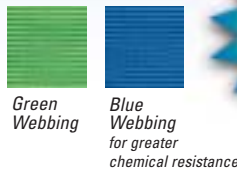
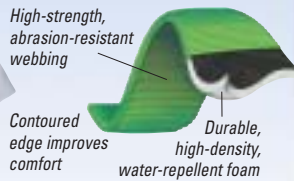

Relief Step™ Safety Device Helps Prevent Suspension Trauma!
(See page 13 for details)

DuraFlex® Ultra Harness

The new line of Ultra Harnesses is designed with patented DuraFlex **stretchable webbing** that provides greater comfort, increases productivity and improves safety.

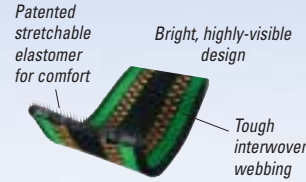

#P950QC-77/UGN

#E650QC-7/UGN

Model	Sizes	Back D-Ring	Front D-Ring	Side D-Rings	Chest Strap Buckle	Shoulder Strap Buckles	Leg Strap Buckles	Special Features
DuraFlex Python Ultra Harness								
P950QC/UGN	U	Yes	Option	No	Quick-Connect	Friction	Quick-Connect	Comfort-touch back D-ring pad / Belt loops
P950QC-7/UGN	U	Yes	Option	Yes	Quick-Connect	Friction	Quick-Connect	Comfort-touch back D-ring pad / Belt loops
P950QC-77/UGN	U	Yes	Option	Yes	Quick-Connect	Friction	Quick-Connect	Comfort-touch back D-ring pad / Belt loops / Body belt
New! P950QC-4/XXXLGN	XXXL Only	Yes	Option	No	Quick-Connect	Friction	Tongue	Comfort-touch back D-ring pad / Belt loops / Body belt
DuraFlex Ultra Harness								
E650QC/UGN	U	Yes	Option	No	Quick-Connect	Friction	Quick-Connect	Comfort-touch back D-ring pad / Belt loops
E650QC-7/UGN	U	Yes	Option	Yes	Quick-Connect	Friction	Quick-Connect	Comfort-touch back D-ring pad / Belt loops
E650QC-77/UGN	U	Yes	Option	Yes	Quick-Connect	Friction	Quick-Connect	Comfort-touch back D-ring pad / Belt loops / Body belt

Model numbers listed are for universal size. Harnesses are also available in small/medium and XXLarge, by replacing the "U" in the model number with "S/M" or "XXL".
Note: For front D-ring vest-style option, add "FD" to the corresponding harness model number (Ex: P950QC^{FD}/UGN).
For greater chemical-resistant blue webbing, substitute "BL" for "GN" in the suffix of the corresponding harness model number (Ex: E650QC-7/UBL).

HARNESS SIZING CHART

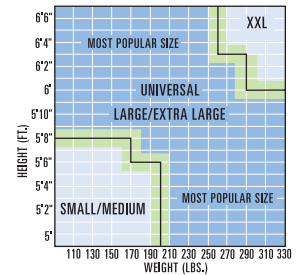

Miller Technical Support
800/873-5242
www.millerfallprotection.com

Miller DuraFlex Python® Harnesses



The DuraFlex Python Harness features wraparound comfort and is uniquely constructed with three types of performance webbing.

- 1 **Cushioned tubular webbing shoulder straps**
The shoulder straps are constructed of soft, cushioned webbing that minimizes possible irritation around the neck and shoulders, and reduces stress to shoulders when using a tool belt.
- 2 **DuraFlex webbing torso straps**
DuraFlex webbing stretches with body movement for greater flexibility, mobility and less fatigue.
- 3 **Non-stretch webbing leg straps**
Non-stretch nylon webbing is lightweight and durable.



Durable, high-density, water-repellent foam

RATED TO 400 lbs.
(181.4kg)
CAPACITY

Discover Wraparound Comfort



Manyard® II #216M/6FTGN

#P950-7/UGN

Relief Step™ Safety Device Helps Prevent Suspension Trauma!
(See page 13 for details)



Cushioned Tubular Webbing

DuraFlex Stretchable Webbing

Lightweight Non-stretch Webbing

#P950-7/UGN

- High-strength, abrasion-resistant, cushioned tubular webbing
- Webbing has a contoured edge for improved comfort, and encases durable, high-density, water-repellent foam
- The Python harness is tangle-free, holds its shape for easier donning
- Back strap prevents user from falling out of the harness
- Injection-molded Santoprene® D-ring back pad is soft and flexible enhancing comfort
- Available in green webbing or blue webbing for greater chemical resistance
- Pull-free lanyard rings allow user to attach lanyard when not in use



HARNESS SIZING CHART

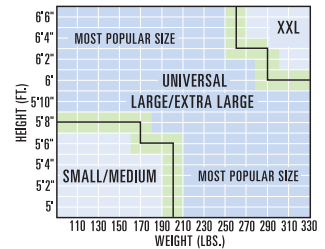

Model	Sizes	Back D-Ring	Front D-Ring	Side D-Rings	Shoulder Strap Buckles	Leg Strap Buckles	Chest Strap Buckle	Sub-Pelvic Strap	Special Features
P950/UGN	U	Yes	Option	No	Friction	Mating	Mating	Yes	Santoprene® D-ring back pad / Pull-free lanyard rings / Belt loops
P950-4/UGN	U	Yes	Option	No	Friction	Tongue	Mating	Yes	Santoprene® D-ring back pad / Pull-free lanyard rings / Belt loops
P950-7/UGN	U	Yes	Option	Yes	Friction	Mating	Mating	Yes	Santoprene® D-ring back pad / Pull-free lanyard rings / Belt loops
P950-58/UGN	U	Yes	Option	Yes	Friction	Tongue	Mating	Yes	Santoprene® D-ring back pad / Pull-free lanyard rings / Belt loops
P950-77/UGN	U	Yes	Option	Yes	Friction	Tongue	Mating	Yes	Santoprene® D-ring back pad / Pull-free lanyard rings / Belt loops / Removable tool belt / 6" (152mm) back pad
P950-78/UGN	U	Yes	Option	Yes	Friction	Mating	Mating	Yes	Santoprene® D-ring back pad / Pull-free lanyard rings / Belt loops / Removable tool belt / 6" (152mm) back pad

Model numbers listed are for universal size. Harnesses are also available in small/medium and XXLarge, by replacing the "U" in the model number with "S/M" or "XXL".
 Note: For front D-ring vest-style option, add "FD" to the corresponding harness model number (Ex: P950FD/UGN).
 For greater chemical-resistant blue webbing, substitute "BL" for "GN" in the suffix of the corresponding harness model number (Ex: P950-7/UBL).
 Santoprene® is a registered trademark of Monsanto Corporation.

Miller DuraFlex® Harnesses

Miller DuraFlex Harnesses feature specially-formulated elastomer webbing that stretches to provide:

Greater Comfort

DuraFlex Harnesses conform to the shape of the worker, stretching with every movement, so there is no bunching, binding or kinking.

Improved Safety

With comfort unsurpassed, DuraFlex Harnesses offer wider end-user acceptance. And, a comfortable harness is worn properly, enhancing compliance and safety on the jobsite.

Increased Productivity

Because DuraFlex Harnesses are stretchable, the worker has greater mobility with less fatigue.

Patented stretchable elastomer for comfort



Feel the Difference!

RATED TO 400 lbs.
(181.4kg)
CAPACITY

Relief Step™ Safety Device Helps Prevent Suspension Trauma!
(See page 13 for details)



#E650-4/UGN

- Synthetic elastomer webbing stretches with the worker for maximum comfort
- Bright, stylish designs are readily visible from a distance
- Solid-colored leg straps help the wearer orient the harness for ease of donning
- Back strap prevents user from falling out of the harness
- Pull-free lanyard rings allow user to attach lanyard when not in use

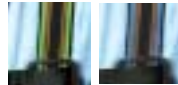

- Available in green webbing or blue webbing for greater chemical resistance

Model	Sizes	Back D-Ring	Front D-Ring	Side D-Rings	Shoulder Strap Buckles	Leg Strap Buckles	Chest Strap Buckle	Sub-Pelvic Strap	Special Features
DuraFlex Series 650									
E650/UGN	U	Yes	Option	No	Friction	Mating	Mating	Yes	Pull-free lanyard rings / Belt loops
E650-4/UGN	U	Yes	Option	No	Friction	Tongue	Mating	Yes	Pull-free lanyard rings / Belt loops
E650-7/UGN	U	Yes	Option	Yes	Friction	Mating	Mating	Yes	Pull-free lanyard rings / Belt loops
E650-58/UGN	U	Yes	Option	Yes	Friction	Tongue	Mating	Yes	Pull-free lanyard rings / Belt loops
DuraFlex Construction Harness									
E650-77/UGN	U	Yes	Option	Yes	Friction	Tongue	Mating	Yes	Permanently-attached back pad
E650-78/UGN	U	Yes	Option	Yes	Friction	Mating	Mating	Yes	Belt loops / Removable body belt / Pull-free lanyard rings
DuraFlex Tower Climbing Harness									
E650-88/UGN	U	Yes	Yes	Yes	Friction	Mating	Mating	Yes	Attached body belt w/two accessory rings / Back pad / Includes vest-style front D-ring
E650-89/UGN	U	Yes	Yes	Yes	Friction	Tongue	Mating	Yes	Padded saddle seat w/two D-rings / Pull-free lanyard rings / Includes vest-style front D-ring
DuraFlex Ms. Miller® Harness									
E570/URN	U	Yes	No	No	Friction	Mating	Mating	No	Front positioning loop / Back and leg pads / Pull-free lanyard rings
DuraFlex Warehouse Picker's Harness									
E850-2/UGN	U	Yes	No	No	Friction	Mating	Mating	Yes	Back D-ring web extension / Pull-free lanyard rings
Other DuraFlex Harnesses									
E550/UGN	U	Yes	Yes	No	Mating	Mating	–	Yes	Pull-free lanyard rings
E552/UGN	U	Yes	Yes	Yes	Mating	Mating	–	Yes	Pull-free lanyard rings
E850/UGN	U	Yes	No	No	Friction	Mating	Mating	Yes	Pull-free lanyard rings
E850-4/UGN	U	Yes	No	No	Friction	Tongue	Mating	Yes	Pull-free lanyard rings
E850-7/UGN	U	Yes	No	Yes	Friction	Mating	Mating	Yes	Pull-free lanyard rings
E850-58/UGN	U	Yes	No	Yes	Friction	Tongue	Mating	Yes	Pull-free lanyard rings

Model numbers listed are for universal size. Harnesses are also available in small/medium and XXLarge, by replacing the "U" in the model number with "S/M" or "XXL".

Note: For front D-ring vest-style option, add "FD" to the corresponding harness model number (Ex: E650FD/UGN).

For greater chemical-resistant blue webbing, substitute "BL" for "GN" in the suffix of the corresponding harness model number (Ex: E650-7/UBL).

Titan T-Flex™ Stretchable Harnesses



Titan by Miller™ T-Flex Harnesses are user friendly and safe. A cost-effective fall protection alternative without sacrificing comfort.

RATED TO 310 lbs.
(140.6kg)
CAPACITY

- Durable, stretch webbing for improved comfort and greater mobility
- Fully-adjustable design for maximum comfort
- Non-slip chest strap assures proper fit
- Sub-pelvic strap for added safety and support
- Leg strap webbing in a contrasting color for ease of donning
- Back strap increases safety by preventing roll out in the event of a fall
- Sliding back D-ring and pad ensure correct back D-ring positioning
- Pull-free lanyard rings for added convenience

Patented stretchable elastomer for comfort



Relief Step™ Safety Device Helps Prevent Suspension Trauma!
(See page 13 for details)

#TF4000/U

Refer to full-line **Titan Fall Protection** catalog for more information.



#TF4507/U

Model	Sizes	Back D-Ring	Front D-Ring	Side D-Rings	Shoulder Strap Buckles	Leg Strap Buckles	Chest Strap Buckle	Sub-Pelvic Strap	Special Features
TF4000/U	U	Yes	Option	No	Mating	Mating	Mating	Yes	Pull-free lanyard rings
TF4500/U	U	Yes	Option	No	Mating	Tongue	Mating	Yes	Pull-free lanyard rings
TF4007/U	U	Yes	Option	Yes	Mating	Mating	Mating	Yes	Pull-free lanyard rings
TF4507/U	U	Yes	Option	Yes	Mating	Tongue	Mating	Yes	Pull-free lanyard rings
TF4577/U*	U	Yes	Option	Yes	Mating	Tongue	Mating	Yes	Back pad / Pull-free lanyard rings / Removable tool belt / Belt loops

Model numbers listed are for universal size. Harnesses are also available in small/medium and XXlarge, by replacing the "U" in the model number with "S/M" or "XXL".
Note: For front D-ring vest-style option, add "FD" to the suffix of the corresponding harness model number (Ex: TF4000FD/U).
*Contractor harness also features a removable tool belt and back pad with side D-rings for positioning.

Miller Body Belts

As of January 1, 1998, OSHA requires full-body harnesses for fall protection in the construction industry. Body belts should be used for work positioning only or be used in conjunction with a full-body harness to provide fall protection.



#2NA



#123N

Model	Description
2NA	Body belt with tongue buckle, includes side D-rings and 3" (76mm) back pad
3NA	Body belt with tongue buckle, includes single D-ring and 3" (76mm) back pad
123N	Lined body belt with tongue buckle, includes single D-ring
124N	Lined body belt with tongue buckle, includes side D-rings

Body Belt Sizing

When ordering, indicate size by using the following suffixes:
For Small: 32" - 40" (813 - 1016mm), add "/SBK" (Ex.: 2NA/SBK)
Medium: 36" - 44" (914 - 1117mm), add "/MBK"
Large: 42" - 48" (1067 - 1219mm), add "/LBK"
X-Large: 44" - 52" (1117 - 1320mm), add "/XLBK"
XX-Large: add "/XXLBK"
Note: XX-Small and X-Small sizes available upon request.



Miller HP™ (High Performance) Harnesses

- Bright colors make the HP harnesses readily visible and easy to inspect
- Back strap prevents user from falling out of the harness
- Comfort-touch back D-ring pad standard on all HP harnesses
- Pull-free lanyard rings allow user to attach lanyard when not in use
- Special features include belt loops, 6-inch (152mm) back pad/tool belt and shoulder pads
- Available in green webbing or blue webbing for greater chemical resistance



RATED TO 400 lbs.
(181.4kg)
CAPACITY



#650T4/UGN



#913TWLS/6FTGN

Miller HP Harnesses are available in three styles:

Pull-Up Adjustment



#650T/UGN

Front D-Ring



#552T/UGN

Pull-Down Adjustment



#850T/UGN

Relief Step™ Safety Device Helps Prevent Suspension Trauma!
(See page 13 for details)

HARNES SIZING CHART

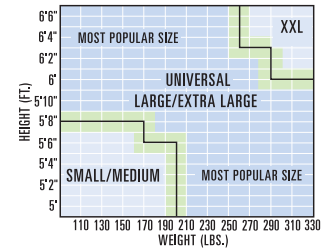

Model	Sizes	Back D-Ring	Front D-Ring	Side D-Rings	Shoulder Strap Buckles	Leg Strap Buckles	Chest Strap Buckle	Sub-Pelvic Strap	Special Features
Pull-Up Adjustment Style									
650T/UGN	U	Yes	Option	No	Friction	Mating	Mating	Yes	Pull-free lanyard rings / Belt loops
650T4/UGN	U	Yes	Option	No	Friction	Tongue	Mating	Yes	Pull-free lanyard rings / Belt loops
650T7/UGN	U	Yes	Option	Yes	Friction	Mating	Mating	Yes	Pull-free lanyard rings / Belt loops
650T58/UGN	U	Yes	Option	Yes	Friction	Tongue	Mating	Yes	Pull-free lanyard rings / Belt loops
650T61/UGN	U	Yes	Option	Yes	Friction	Tongue	Mating	Yes	Shoulder pads / Back pad / Lanyard rings / Belt loops / Removable waist belt
650T76/UGN	U	Yes	Option	Yes	Friction	Tongue	Mating	Yes	6" (152mm) back pad / tool belt / Shoulder pads / Pull-free lanyard rings / Belt loops
650T77/UGN	U	Yes	Option	Yes	Friction	Tongue	Mating	Yes	6" (152mm) back pad / tool belt / Pull-free lanyard rings / Belt loops
Front D-Ring Style									
552T/UGN	U	Yes	Yes	Yes	Mating	Mating	–	Yes	Pull-free lanyard rings
552T4/UGN	U	Yes	Yes	Yes	Mating	Tongue	–	Yes	Pull-free lanyard rings
Pull-Down Adjustment Style									
850T/UGN	U	Yes	No	No	Friction	Mating	Mating	Yes	Pull-free lanyard rings
850T4/UGN	U	Yes	No	No	Friction	Tongue	Mating	Yes	Pull-free lanyard rings
850T7/UGN	U	Yes	No	Yes	Friction	Mating	Mating	Yes	Pull-free lanyard rings
850T58/UGN	U	Yes	No	Yes	Friction	Tongue	Mating	Yes	Pull-free lanyard rings

Model numbers listed are for universal size. Harnesses are also available in small/medium and XXLarge, by replacing the "U" in the model number with "S/M" or "XXL".

Note: For front D-ring vest-style option, add "FD" to the corresponding harness model number (Ex: 650TFD/UGN).

For greater chemical-resistant blue webbing, substitute "BL" for "GN" in the suffix of the corresponding harness model number (Ex: 650T7/UBL).

Miller Yellow Non-Stretch Harnesses

RATED TO 400 lbs.
(181.4kg)
CAPACITY

Model	Sizes	Back D-Ring	Front D-Ring	Side D-Rings	Shoulder Strap Buckles	Leg Strap Buckles	Chest Strap Buckle	Sub-Pelvic Strap	Special Features
650/UYK	U	Yes	Option	No	Friction	Mating	Mating	Yes	Pull-free lanyard rings / Belt loops
650-4/UYK	U	Yes	Option	No	Friction	Tongue	Mating	Yes	Pull-free lanyard rings / Belt loops / Fall indicator
650-7/UYK	U	Yes	Option	Yes	Friction	Mating	Mating	Yes	Pull-free lanyard rings / Belt loops / Fall indicator
650-58/UYK	U	Yes	Option	Yes	Friction	Tongue	Mating	Yes	Pull-free lanyard rings / Belt loops / Fall indicator
650-77/UYK	U	Yes	Option	Yes	Friction	Tongue	Mating	Yes	Permanently-attached back pad
550/UYK	U	Yes	Yes	No	Mating	Mating	–	Yes	Pull-free lanyard rings / Fall indicator
552/UYK	U	Yes	Yes	Yes	Mating	Mating	–	Yes	Pull-free lanyard rings / Fall indicator
750/UYK	U	Yes	No	No	Friction	–	Mating	No	Pull-free lanyard rings / Fall indicator
751/UYK	U	Yes	Option	No	–	Mating	Mating	Yes	Pull-free lanyard rings / Fall indicator
850/UYK	U	Yes	No	No	Friction	Mating	Mating	Yes	Pull-free lanyard rings / Fall indicator
850-4/UYK	U	Yes	No	No	Friction	Tongue	Mating	Yes	Pull-free lanyard rings
850-7/UYK	U	Yes	No	Yes	Friction	Mating	Mating	Yes	Pull-free lanyard rings
850-58/UYK	U	Yes	No	Yes	Friction	Tongue	Mating	Yes	Pull-free lanyard rings



#650/UYK

Model numbers listed are for universal size. Harnesses are also available in small/medium and XXlarge, by replacing the "U" in the model number with "S/M" or "XXL".
Note: For front D-ring vest-style option, add "FD" to the corresponding harness model number (Ex: 650FD/UYK).

Miller High-Visibility Vests

The Miller High Viz Vest is designed for use with, or without, a Miller full-body harness. Available in lime yellow, the vest meets the Department of Transportation (DOT) requirements and the ANSI Class 3 High-Visibility Standard.

- Removable harness design provides flexibility for a variety of applications
- Vest and harness sold separately reducing costs when either component is damaged or needs replacement

Model	Description
HIVIZVEST	Specify size: /M; /L; /XL; /XXL



Miller Harness Accessories



Harness Accessory	Model	Description
1 - Body Belt	6414N/UBK	1-3/4" (44mm) black web belt; tongue buckle with 11 grommets; universal size
2 - D-Ring Extension (not shown)	8928/18INBK	18" (457mm) web extension with a snap hook and a D-ring on the opposite end (See page 5, Warehousing)
3 - Back Pad	9014/BK	6" (152mm) wide pad for added comfort
Back Pad	9016/BK	8" (203mm) wide pad for added comfort
4 - Shoulder Pads	9017/3X9INBK	With anti-slide rubber grip bar
5 - Pull-Free Lanyard Rings (not shown)	9060	For attaching a lanyard when not in use
6 - Reflective Velcro® Sleeve	9052/6INGN	Fluorescent lime green reflective material affixes to the straps of a harness for use in no or low light conditions; available in 25' (7.6m) rolls that can be cut to desired length
Reflective Velcro® Sleeve	9053/6INOR	Fluorescent orange reflective material
7 - Back D-Ring Pad (not shown)	9090/7X8INBK	Removable harness back D-ring pad 7" x 8" (178mm x 203mm). Attaches to any harness with stainless steel snaps. (See page 6)
8 - Relief Step Safety Device	–	(See page 13 for details)

Velcro is a registered trademark of VELCRO USA Inc.

Miller Relief Step™ Safety Device

New!

**RELIEF
STEP™
SAFETY DEVICE**

*Helps Prevent
Suspension Trauma!*

The Miller Relief Step Safety Device alleviates the effects of orthostatic intolerance, also known as suspension trauma. If a fall occurs, a person becomes suspended in a harness and remains both vertical and sedentary for a period of time, causing blood to "pool" in the veins of the legs. Subsequently, blood is restricted to the brain and other major organs that may initially result in unconsciousness. If not rescued promptly, serious injury or death may occur. The Miller Relief Step is designed to provide a short-term solution for alleviating suspension trauma.

- OSHA states that potentially fatal suspension trauma can occur within minutes while waiting for rescue after a fall
- Average fall rescue time is 15 minutes
- When used, the Relief Step Safety Device provides support and enhances blood circulation until rescue – permitting the ability to move and flex leg muscles
- Small and lightweight; the Relief Step Safety Device attaches to **any brand** full-body harness
- Utilizing two (2) Relief Steps (one for each leg/foot) assures greater comfort until rescue is completed



Model	Description
9099X/12	Consists of a box of 12 Relief Step Safety Devices
9099/36BULK	36 Relief Step Safety Devices in bulk quantity

Easy to Deploy and Use (Attaches to any brand full-body harness)



1 Pull tab to deploy



2 Insert foot into loop step and adjust



3 Ability to stand allowing improved circulation



4 Two Relief Steps provide added support, balance and comfort

Miller Rescue Ladder



#9058/15FTBK
Aerial Lift Rescue Ladder

The Miller Aerial Lift Rescue Ladder is a portable 15-foot (4.6m) nylon web ladder designed and intended to assist with self-rescue for applications such as aerial lifts, bucket trucks and elevated work surfaces.

In the event of a fall, the user releases the ladder by pulling on the drawstring and then climbs back to the work surface.

Miller Technical Support
800/873-5242
www.millerfallprotection.com

Miller DuraFlex® Utility Harnesses

Miller Utility Harnesses minimize the amount of hardware above the waist to reduce electrical conductivity. In addition, the harnesses are independently thermal-arc tested to ensure superior performance.



#E752/UGN

- Stretchable webbing design
- Web loop lanyard attachment reduces the chance of electric shock
- Self-rescue positioning loops provide a positioning attachment point and may be used with bucket escape systems
- Chest strap adjustment/protective pads hold chest strap in place and keep the mating buckle away from the body
- Adjustable belt loops accommodate linemen's belts
- Available in green webbing or blue webbing for greater chemical resistance
- Now rated to 400 lbs. (181.4kg) capacity



Web loop

Self-rescue positioning loops

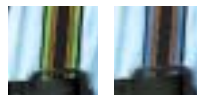

#E752/UGN



Relief Step™ Safety Device Helps Prevent Suspension Trauma!
(See page 13 for details)

Model	Sizes	Back D-Ring	Front D-Ring	Side D-Rings	Leg Strap Buckles	Chest Strap Buckle	Sub-Pelvic Strap	Special Features
E752/UGN*	U	Web Loop	No	No	Mating	Mating	Yes	Chest strap adjustment / protective pads / Adjustable belt loops
E753/UGN*	U	Web Loop	No	No	Mating	Mating	Yes	Chest strap adjustment / protective pads / Adjustable belt loops / Self-rescue positioning loops

Model numbers listed are for universal size. Harnesses are also available in small/medium and XXLarge, by replacing the "U" in the model number with "S/M" or "XXL".

*In Canada, utility harnesses include a back D-ring extension in place of the web loop to meet CSA requirements.

For greater chemical-resistant blue webbing, substitute "BL" for "GN" in the suffix of the corresponding harness model number (Ex: E752/UBL).

Miller StopFall® System



StopFall Video Available

Linemen's Belt #93N

Utility Harness #E752/UGN

The Miller StopFall System provides a user-friendly and reliable work positioning and fall arrest system for climbing wooden poles. The StopFall System is specifically designed with a 75-inch (1905mm) pole strap (maximum length) and features a 21-inch (533mm) security strap with unique gaffs that "bite" into wooden poles. Meets CSA Standard Z259.14-99 for Type A and Type AB.

Model 7600A StopFall System fits wood pole size 25" - 50" (635mm - 1270mm) circumference with **friction buckle** adjustment.

Model 7600B StopFall System fits wood pole size 25" - 50" (635mm - 1270mm) circumference with **tongue buckle** adjustment.

The polyester pole strap comprises:

- An integral steel reinforcement band, which prevents "hour-glassing" and maintains shape
- A rugged neoprene wear pad for increased service life
- Double-locking snap hooks and length adjuster assembly
- Two-piece spring assembly to prevent a continual electric path
- Stainless steel dome stops to prevent the security strap from inadvertently sliding off the end of the wear pad

Specially-designed security strap

- Corrosion-resistant, stainless steel hardware
- Spring-loaded gaffs that provide instant grip on wooden poles
- Nylon rollers permit free movement of the gaffs and minimize abrasion on the strap
- A disconnect and length adjuster with a "parking" feature for when the security strap is not in use

Miller Safety Straps

Miller brand safety straps are equipped with locking snap hooks and are constructed with a red inner core/wear indicator. Should the red core become exposed, the strap must be removed from service.



#6NFLS/6FTYL

#6YRLS/6FTBR

NF Series Safety Strap

A 1-3/4 inch (44mm) wide, 100% nylon safety strap offers a friction buckle to adjust the length of the strap quickly and easily.

Model 6NFLS/6FTYL - 6 ft. (1.8m) length

Model 7NFLS/7FTYL - 7 ft. (2.1m) length

YR Series Safety Strap

Strong safety strap, made of a six-ply nylon, remains flexible in all types of weather conditions. Tongue buckle adjuster included for quick, safe adjustment.

Model 6YRLS/6FTBR - 6 ft. (1.8m) length

Model 7YRLS/7FTBR - 7 ft. (2.1m) length

Miller Linemen's Belts

Miller Linemen's Belts combine superior design characteristics and handmade craftsmanship to create products of the highest quality every time.

All Miller Linemen's Belts feature:

- Side positioning D-rings
- Support belt rings
- Leather tool loops
- Tape thong
- Accessory snap
- Accessory ring

Fixed Belts

Fixed belts do not allow for lateral movement of the D-rings or waist strap with tool loops.

Semi-Floating Belts

On semi-floating belts, the waist strap with tool loops is completely separate from the D-saddle, allowing for lateral movement of the waist strap prior to use. Any load or pull does not bind tools to tool loops.

Full-Floating Belts

Full-floating belts allow for lateral movement of the D-saddle with D-rings during use. As a lineman changes position on a pole, the D-rings easily adjust to the movement. As a result, the pole strap rubs against the pole less frequently and receives less wear. Any load or pull does not bind tools to the tool loops.



#8449



#75N



#93N



#94N



#60NL



#95N



#88N

Model	Style	Width	Construction	Weight
60NL	Fixed	4" (101mm)	Body pad with soft dielectric lining and 1-3/4" (44mm) waist strap	3.9 lbs. (1.7kg)
93N	Fixed	5" (127mm)	Body pad with soft dielectric leather lined 1-3/4" (44mm) waist strap	3.8 lbs. (1.7kg)
94N	Semi-floating	4" (101mm)	Leather body pad with 1-3/4" (44mm) waist strap	4.0 lbs. (1.8kg)
95N	Full-floating	5" (127mm)	Leather body pad with 1-3/4" (44mm) waist strap	4.6 lbs. (2.0kg)
99N	Fixed	9" (228mm)	Leather back-saver body pad with 1-3/4" (44mm) waist strap	3.9 lbs. (1.7kg)
93YR	Semi-floating	5" (127mm)	MillerHyde™ II synthetic leather body pad with 1-3/4" (44mm) waist strap	3.9 lbs. (1.7kg)
75N	Full-floating	5" (127mm)	MillerHyde™ II synthetic leather body pad with a D-saddle and 1-3/4" (44mm) waist strap	4.9 lbs. (2.2kg)
88N	Full-floating	9" (228mm)	Leather back-saver body pad with a D-saddle and 1-3/4" (44mm) waist strap	5.6 lbs. (2.5kg)
8449	Full-floating	5" (127mm)	Leather, cushioned body pad with 1-3/4" (44mm) leather D-saddle and waist strap	4.5 lbs. (2.0kg)

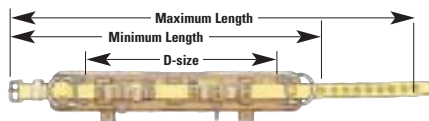

Linemen's Belt Sizing

The degree of comfort a lineman receives from a belt depends on the construction of the belt and the location of the D-rings. For best fit, order by D-size. The D-size is the distance between the heels of the D-rings. When wearing a belt, the D-rings should be located 1 inch (25mm) in front of the hip bones. To determine proper D-size, measure across the back from hip bone to hip bone and add 2 inches (51mm). This measurement is the D-size.

Miller SideWinder™

Retractable Web Lanyard

Model #8327SW/8FTYL

- Provides protection where a pole strap cannot... while climbing past pole obstructions. Simply pull out the webbing and wrap around the pole. Then proceed to unhook and re-hook the pole strap. Easily attaches to any standard linemen's belt. Weighs only 3.7 lbs. (1.8kg).



Sizing Chart for Linemen's Belts

D-Size	D18	D19	D20	D21	D22	D23	D24	D25	D26	D27	D28	D29	D30
Min.	32" (800mm)	33" (825mm)	34" (850mm)	35" (875mm)	36" (900mm)	38" (950mm)	40" (1000mm)	42" (1050mm)	44" (1100mm)	46" (1150mm)	47" (1175mm)	48" (1200mm)	49" (1225mm)
Max.	42" (1050mm)	43" (1075mm)	44" (1100mm)	45" (1125mm)	46" (1150mm)	48" (1200mm)	50" (1250mm)	52" (1300mm)	54" (1350mm)	56" (1400mm)	57" (1425mm)	58" (1450mm)	59" (1475mm)

Miller Rescue Ladder



#9058/15FTBK
Aerial Lift Rescue Ladder

The Miller Aerial Lift Rescue Ladder is a portable 15-foot (4.6m) nylon web ladder designed and intended to assist with self-rescue for applications such as aerial lifts, bucket trucks and elevated work surfaces.

In the event of a fall, the user releases the ladder by pulling on the drawstring and then climbs back to the work surface.

Miller Shock-Absorbing Lanyards

Manyard® II Stretchable Shock-Absorbing Lanyards

Contracts 6 ft. (1.8m) to 4 ft. (1.2m), Manyard II Lanyards greatly reduce the chances of tripping, snagging or dragging.

- Specially-woven shock-absorbing inner core smoothly expands up to 42 inches (1.1m) to reduce fall arrest forces
- Heavy-duty tubular outer jacket serves as a back-up lanyard
- Unique warning flag provides visual proof that a lanyard has been involved in a fall and must be removed from service
- Integral bright red core makes visual inspection easier and more reliable
- Available in green or blue webbing for greater chemical resistance



Model	Material	Number of Legs	Harness Connection	Anchorage Connection	Special Features	Standard Length*
216M/6FTGN	Webbing	One	Locking snap hook	Locking snap hook	Warning flag / Red core wear indicator	6' (1.8m)
219M/6FTGN	Webbing	One	Locking snap hook	Locking rebar hook	Warning flag / Red core wear indicator	6' (1.8m)
231M/6FTGN	Webbing	Two	Locking snap hook	Locking rebar hooks	Warning flag / Red core wear indicator	6' (1.8m)
232M/6FTGN	Webbing	Two	Locking snap hook	Locking snap hooks	Warning flag / Red core wear indicator	6' (1.8m)
233M/6FTGN	Webbing	One	Choke-off loop	Locking snap hook	Warning flag / Red core wear indicator	6' (1.8m)

Green Webbing
Blue Webbing for greater chemical resistance

*Available in lengths from 4 ft. (1.2m) to 10 ft. (3m). For greater chemical-resistant blue webbing, substitute "BL" for "GN" in the suffix of the corresponding lanyard model number (Ex: 216M/6FTBL). Note: Locking Snap Hook – 3/4-inch (19mm) gate opening; Locking Rebar Hook – 2-1/2 inch (63mm) gate opening.

Miller Manyard® HP™ Shock-Absorbing Lanyards

- Specially-woven shock-absorbing inner core smoothly expands up to 42 inches (1.1m) to reduce fall arrest forces
- Heavy-duty tubular outer jacket serves as a back-up web lanyard
- Unique warning flag provides visual proof that a lanyard has been involved in a fall and must be removed from service
- Available in green webbing or blue webbing for greater chemical resistance

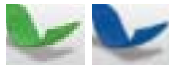

Model	Material	Number of Legs	Harness Connection	Anchorage Connection	Special Features	Standard Lanyard Length*
216TWLS/6FTGN	Webbing	One	Locking snap hook	Locking snap hook	Warning flag	6' (1.8m)
219TWRS/6FTGN	Webbing	One	Locking snap hook	Locking rebar hook	Warning flag	6' (1.8m)
231TWRS/6FTGN	Webbing	Two	Locking snap hook	Two locking rebar hooks	Warning flag	6' (1.8m)
232TWLS/6FTGN	Webbing	Two	Locking snap hook	Two locking snap hooks	Warning flag	6' (1.8m)
233TWLS/6FTGN	Webbing	One	Web choke-off loop	Locking snap hook	Warning flag	6' (1.8m)
233TWRS/6FTGN	Webbing	One	Web choke-off loop	Locking rebar hook	Warning flag	6' (1.8m)
266TWLS/6FTGN	Webbing	Two	Web choke-off loop	Two locking snap hooks	Warning flag	6' (1.8m)
266TWRS/6FTGN	Webbing	Two	Web choke-off loop	Two locking rebar hooks	Warning flag	6' (1.8m)

*Also available in lengths from 4 ft. (1.2m) to 10 ft. (3m). For greater chemical-resistant blue webbing, substitute "BL" for "GN" in the suffix of the corresponding lanyard model number (Ex: 216TWLS/6FTBL). Note: Locking Snap Hook – 3/4-inch (19mm) gate opening; Locking Rebar Hook – 2-1/2 inch (63mm) gate opening.

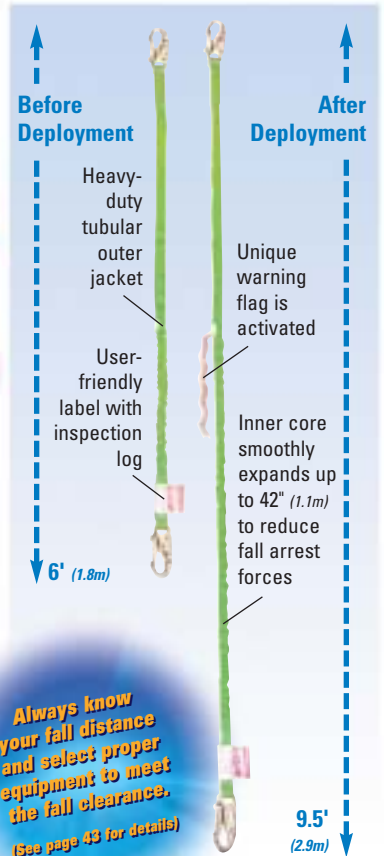

Always know your fall distance and select proper equipment to meet the fall clearance.
(See page 43 for details)

9.5' (2.9m)

Manyard® Shock-Absorbing Lanyards

With 20 years of design refinement, the "original" Manyard Shock-Absorbing Lanyards are unsurpassed in the market for safety, comfort and mobility.

- Specially-woven, shock-absorbing inner core smoothly expands up to 42 inches (1.1m) to reduce fall arrest forces
- Heavy-duty tubular outer jacket serves as a back-up lanyard
- Unique warning flag provides visual proof that a lanyard has been involved in a fall and must be removed from service



#216WLS/6FTYL

#232WLS/6FTYL

Reduces Fall Arrest Forces

#216WLS/6FTYL

DuraFlex®
Harness
#E650-77/UGN

Model	Material	Number of Legs	Harness Connection	Anchorage Connection	Special Features	Standard Length*
216WLS/6FTYL	Webbing	One	Locking snap hook	Locking snap hook	Warning flag	6' (1.8m)
219WRS/6FTYL	Webbing	One	Locking snap hook	Locking rebar hook	Warning flag	6' (1.8m)
231WRS/6FTYL	Webbing	Two	Locking snap hook	Locking rebar hooks	Warning flag	6' (1.8m)
232WLS/6FTYL	Webbing	Two	Locking snap hook	Locking snap hooks	Warning flag	6' (1.8m)
233WLS/6FTYL	Webbing	One	Choke-off loop	Locking snap hook	Warning flag	6' (1.8m)

*Available in lengths from 4 ft. (1.2m) to 10 ft. (3m).

Note: Locking Snap Hook – 3/4-inch (19mm) gate opening; Locking Rebar Hook – 2-1/2 inch (63mm) gate opening.

Always know your fall distance and select proper equipment to meet the fall clearance.
(See page 43 for details)

Miller StretchStop® Lanyards with SofStop® Shock Absorber

Miller StretchStop Lanyards combine the integral SofStop Shock Absorber with a unique stretchable lanyard design.

- Unique stretchable design (4 ft. (1.2m) to 6 ft. (1.8m)), minimizes tripping, snagging and dragging
- SofStop Shock Absorber pack is designed with a specially-woven inner core that smoothly expands up to 42 inches (1.1m) to reduce fall arrest forces
- Includes a heavy-duty back-up safety strap
- Available in green or blue webbing for greater chemical resistance



#8798RSS/6FTGN

#913SS/6FTGN

Model	Material	Number of Legs	Harness Connection	Anchorage Connection	Standard Length*
913SS/6FTGN	Webbing	One	Locking snap hook	Locking snap hook	6' (1.8m)
913RSS/6FTGN	Webbing	One	Locking snap hook	Locking rebar hook	6' (1.8m)
8798SS/6FTGN	Webbing	Two	Locking snap hook	Locking snap hooks	6' (1.8m)
8798RSS/6FTGN	Webbing	Two	Locking snap hook	Locking rebar hooks	6' (1.8m)

*Available in lengths from 4 ft. (1.2m) to 10 ft. (3m). For greater chemical-resistant blue webbing, substitute "BL" for "YL" in the suffix of the corresponding lanyard model number (Ex: 913SS/6FTBL).

Note: Locking Snap Hook – 3/4-inch (19mm) gate opening; Locking Rebar Hook – 2-1/2 inch (63mm) gate opening.

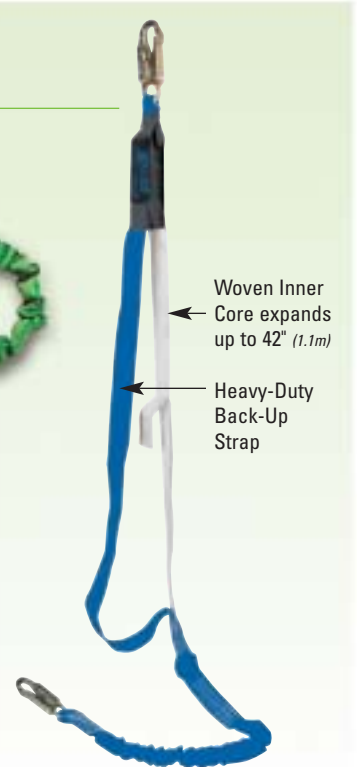

Woven Inner Core expands up to 42" (1.1m)

Heavy-Duty Back-Up Strap

Miller Shock-Absorbing Lanyards

Miller HP™ Lanyards w/SofStop® Shock Absorbers

- The versatile Miller HP web lanyard with a SofStop Shock Absorber pack is designed with a specially-woven inner core that smoothly expands up to 42 inches (1.1m) to reduce fall arrest forces
- Includes heavy-duty back up safety strap
- Available in green webbing or blue webbing for greater chemical resistance



#913TWLS/6FTGN



#8878T/6FTGN

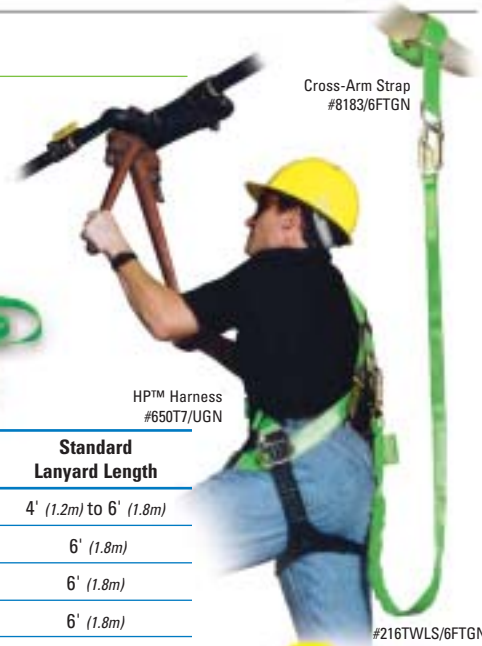

Cross-Arm Strap
#8183/6FTGN

HP™ Harness
#650T7/UGN

#216TWLS/6FTGN

Model	Material	Number of Legs	Harness Connection	Anchorage Connection	Special Features	Standard Lanyard Length
910TWLS/6FTGN	Webbing	One	Locking snap hook	Locking snap hook	Adjustable	4' (1.2m) to 6' (1.8m)
913TWLS/6FTGN	Webbing	One	Locking snap hook	Locking snap hook	–	6' (1.8m)
8798T/6FTGN	Webbing	Two	Locking snap hook	Two locking snap hooks	–	6' (1.8m)
8798TR/6FTGN	Webbing	Two	Locking snap hook	Two locking rebar hooks	–	6' (1.8m)
8878T/6FTGN	Webbing	Two	Locking snap hook	Two locking snap hooks	Adjustable	4' (1.2m) to 6' (1.8m)
8878TR/6FTGN	Webbing	Two	Locking snap hook	Two locking rebar hooks	Adjustable	4' (1.2m) to 6' (1.8m)

For greater chemical-resistant blue webbing, substitute "BL" for "GN" in the suffix of the corresponding lanyard model number (Ex: 910TWLS/6FTBL).
Note: Locking Snap Hook – 3/4-inch (19mm) gate opening; Locking Rebar Hook – 2-1/2 inch (63mm) gate opening.

Miller Lanyards with SofStop® Shock Absorbers

The versatile Miller SofStop Shock Absorber pack is an integral component of various Miller brand rope, wire rope and web shock-absorbing lanyards.

- SofStop Shock Absorber pack is designed with a specially-woven inner core that smoothly expands up to 42 inches (1.1m) to reduce fall arrest forces



#901RLS-2/6FTWH

#907NLS/6FTYL



Python Ultra
Harness
#P950QC/UGN

#901RLS-2/
6FTWH

Model	Material	Number of Legs	Harness Connection	Anchorage Connection	Special Features	Lanyard Length
928LS/18INYL	–	N/A	Locking snap hook	D-ring	–	18" (457mm)
901RLS-2/6FTWH*	5/8" (16mm) Rope	One	Locking snap hook	Locking snap hook	–	6' (1.8m)
903RLS-2/6FTWH*	Rope	One	Locking snap hook	Locking snap hook	Adjustable	6' (1.8m)
907LS/6FTYL	Wire rope	One	Locking snap hook	Locking snap hook	–	6' (1.8m)
907NLS/6FTYL	Vinyl-coated wire rope	One	Locking snap hook	Locking snap hook	–	6' (1.8m)
910WLS/6FTYL*	Webbing	One	Locking snap hook	Locking snap hook	Adjustable	4' (1.2m) to 6' (1.8m)
913WLS/6FTYL*	Webbing	One	Locking snap hook	Locking snap hook	–	6' (1.8m)
940WLS/6FTYL*	Webbing	One	Locking snap hook	Locking snap hook	Double SofStop Pack for 12 ft. (3.7m) free fall / Duty-rated 400 lbs. (181.4kg) capacity	6' (1.8m)
8798-6/6FTYL*	Webbing	Two	Locking snap hook	Locking snap hooks	–	6' (1.8m)
8798-6R/6FTYL*	Webbing	Two	Locking snap hook	Locking rebar hooks	–	6' (1.8m)

*To order polyester, add "-5" to the corresponding model number (Ex: 903RLS-5/6FTWH).
Note: Locking Snap Hook – 3/4-inch (19mm) gate opening; Locking Rebar Hook – 2-1/2 inch (63mm) gate opening.

Miller BackBiter® Tie-Back Lanyards

Miller BackBiter offers the ultimate in tie-back safety! The webbing and snap hooks of regular lanyards are not designed to withstand the rigors of tying back. The innovative Miller BackBiter Tie-Back Lanyard with a 5K Snap Hook was designed from top to bottom for tie-back use.

- All-in-one lanyard with SofStop Shock Absorber and cross-arm anchorage connector
- First snap hook with a 5,000 lb. (22kn) gate load capacity from any angle
- Heavy-duty polyester webbing and Cordura® nylon webbing with five times more abrasion resistance
- Available in green webbing or blue webbing for greater chemical resistance



Featuring the
**Miller 5K®
SNAP HOOK**

The FIRST snap hook with a 5,000 lb. gate load capacity from any angle

*Tie-Back
safely!*



#913B/6FTGN

#8798B/6FTGN

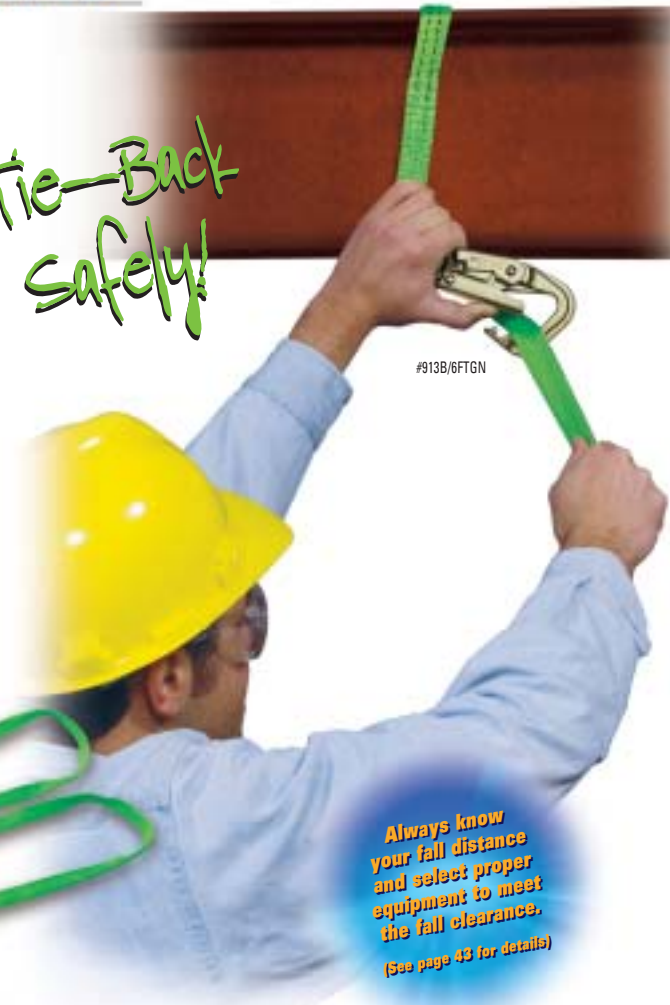

#913B/6FTGN

Always know your fall distance and select proper equipment to meet the fall clearance. (See page 43 for details)

Model	Material	Number of Legs	Harness Connection	Anchorage Connection	Lanyard Length
913B/6FTGN	Webbing	One	Locking snap hook	Locking 5K snap hook	6' (1.8m)
8798B/6FTGN	Webbing	Two	Locking snap hook	Locking 5K snap hooks	6' (1.8m)

For greater chemical-resistant blue webbing, substitute "BL" for "GN" in the suffix of the corresponding lanyard model number (Ex: 913B/6FTBL).
Note: Locking Snap Hook – 3/4-inch (19mm) gate opening.
Cordura is a registered trademark of E. I. DuPont.



Green Webbing



Blue Webbing for greater chemical resistance

Miller Retractable Web Lanyards

Designed for limited-range applications, the Miller Retractable Web Lanyard is lightweight and dependable.

#8327/10FTYL



Model	Description
8327/10FTYL	Compact, retractable lanyard with up to 10' (3m) of polyester webbing, complete with a top-swivel shackle, carabiner and a locking snap hook with 3/4" (19mm) gate opening
8327A/10FTYL	Same as model 8327, except without the carabiner
AD6902/8FTYL	Same as model 8327, except with carabiners at the anchorage and lanyard ends, 8' (2.4m)

"O-Ring" Extension Option



New!

OSHA regulation 1926.502, Section (d) personal fall arrest systems, paragraph (6) states that "snap hooks shall not be engaged to a D-ring to which another snap hook or other connector is attached." This means a retractable unit and a lanyard cannot simultaneously be attached to the same harness back D-ring.

Since it is potentially dangerous, difficult and time-consuming to switch back and forth from a lanyard to a retractable, the new Miller Lanyard "O-ring" option solves this concern by allowing the retractable to be attached to the lanyard O-ring, while the lanyard remains connected to the back D-ring of the harness. This eliminates the need to continually change attachment points from a lanyard to a retractable. The placement of the O-ring is designed so that if a fall occurs, the lanyard shock-absorber will not engage and the retractable unit will arrest the fall.

The Lanyard O-Ring Extension Option is available on any Miller shock-absorbing lanyard, single- or double-legged lanyards. To order, add an "O" as a suffix to the model number (Ex: 913B0; 913SS0).

Miller Self-Retracting Lifelines

Miller Scorpion™ Personal Fall Limiter

The lightweight, compact design of the 9 ft. (2.7m) Miller Scorpion Personal Fall Limiter provides workers an affordable alternative to shock-absorbing lanyards. In a head-to-head comparison with shock-absorbing lanyards, the Scorpion web retractable requires less fall clearance, offers greater mobility and prevents tripping hazards.

- Greater versatility through dual operation:
 - attach directly to the harness D-ring for use as a personal fall limiter, or
 - use as a traditional retractable lifeline
- Small, lightweight design 2.9 lbs. (1.3kg)
- Quick-activating, high-strength stainless steel braking system – arrests free falls
- 9 ft. (2.7m) of working capacity
- Variety of integral anchorage connectors available
- 400 lbs. (181.4kg) capacity models available upon request
- No annual factory recertification required
- Visual load indicator – indicates the unit must be removed from service

An affordable alternative to shock-absorbing lanyards



Python Harness #P950/UGN

#PFL-5/9FT

Model	■ Scorpion Unit Connector Options	■ Scorpion Lanyard End Connector Options
PFL-1/9FT	Scorpion without unit connector	Locking snap hook
PFL-2/9FT	Scorpion w/steel twist-lock carabiner	Locking snap hook
PFL-3/9FT	Scorpion w/stainless steel swivel shackle	Locking snap hook
PFL-4/9FT	Scorpion w/carabiner and swivel shackle	Locking snap hook
PFL-5/9FT	Scorpion w/D-ring swivel hook	Locking snap hook
PFL-6/9FT	Scorpion w/rebar hook and swivel shackle	Locking snap hook
PFL-7/9FT	Scorpion w/locking snap hook and swivel shackle	Locking snap hook
PFL-8/9FT	Scorpion w/captive eye carabiner	Locking snap hook
PFL-9/9FT	Scorpion w/carabiner and swivel shackle	Locking rebar hook
PFL-10/9FT	Scorpion w/D-ring swivel hook	Locking rebar hook
PFL-11/9FT	Scorpion w/locking snap hook and swivel shackle	Locking rebar hook
PFL-12/9FT	Scorpion w/carabiner and swivel shackle	Locking, rebar swivel hook
PFL-13/9FT	Scorpion w/D-ring swivel hook	Locking, rebar swivel hook
PFL-14/9FT	Scorpion w/locking snap hook and swivel shackle	Locking, rebar swivel hook
PFL-15/9FT	Scorpion without unit connector	Locking, swivel snap hook
PFL-16/9FT	Scorpion w/steel twist-lock carabiner	Locking, swivel snap hook
PFL-17/9FT	Scorpion without unit connector	Web loop for carabiner

Note: Locking Snap Hook – 3/4-inch (19mm) gate opening; Locking Rebar Hook – 2-1/2 inch (63mm) gate opening.

Scorpion Unit Connector Options



Scorpion Lanyard End Connector Options

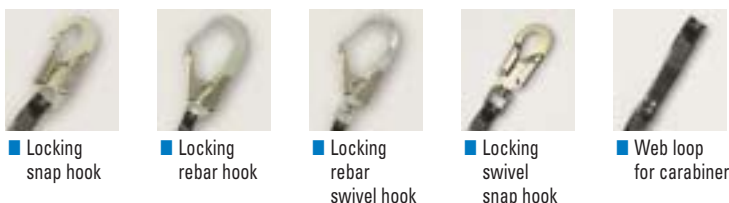

Miller Black Rhino™ Self-Retracting Lifelines

The Black Rhino SRLs are designed with stainless steel wire rope to endure the daily rigors of harsh environments.

Ideal for concrete construction, welding, steel erection, food processing and warehouse applications.

- Lightweight 4.3 lbs. (1.9kg)
- Repairable; no annual factory recertification required – lowering cost of ownership
- Quick-activating, high-strength stainless steel braking system – arrests free falls, providing a quick, safe rescue
- Variety of integral anchorage connectors available – provides ultimate flexibility of use in a variety of applications
- Integral load indicator – indicates when the unit must be removed from service and returned for repair
- Extended service life – corrosion-resistant stainless steel and aluminum components
- Integral internal shock absorber – consistently reduces fall forces to 900 lbs./f (4kN) or less for greater safety
- Rated to 400 lbs. (181.4kg) capacity when using a SofStop shock absorber (928LS/181NYL)



Smallest and lightest
9 ft. cable lifeline
on the market

Python Ultra
Harness
#P950QC/UGN

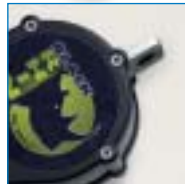
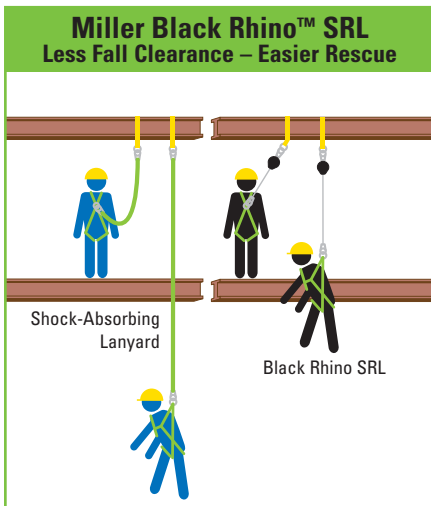

CFL-1/9FT

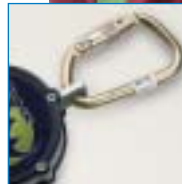

CFL-2/9FT

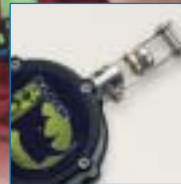

CFL-3/9FT



CFL-4/9FT



CFL-5/9FT

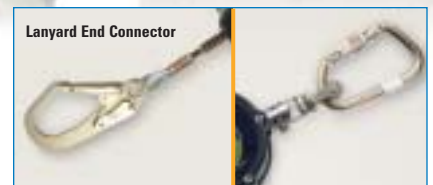

CFL-6/9FT

Model	Unit Connector Option	Lanyard End Connector Options	Standard Length
CFL-1/9FT	None (need carabiner, not included)	Locking, swivel snap hook with load indicator	9' (2.7m)
CFL-2/9FT	Steel twist-lock carabiner	Locking, swivel snap hook with load indicator	9' (2.7m)
CFL-3/9FT	Stainless steel swivel (need carabiner, not included)	Locking, swivel snap hook with load indicator	9' (2.7m)
CFL-4/9FT	Stainless steel swivel and steel twist-lock carabiner	Locking, swivel snap hook with load indicator	9' (2.7m)
CFL-5/9FT	Stainless steel swivel and rebar locking snap hook	Locking, swivel snap hook with load indicator	9' (2.7m)
CFL-6/9FT	Stainless steel swivel and steel twist-lock carabiner	Locking rebar snap hook	9' (2.7m)

Note: Locking Snap Hook – 3/4-inch (19mm) gate opening; Locking Rebar Hook – 2-1/2 inch (63mm) gate opening.

Miller Self-Retracting Lifelines

Miller MiniLite® Fall Limiters

The Miller MiniLite Fall Limiter is an 11 ft. (3.3m) self-retracting web lanyard with a quick-activating braking system that limits free falls. In contrast to shock-absorbing lanyards, a Fall Limiter eliminates the need for extended fall distance clearance, minimizing the risk of injuries and making rescue easier.

- Lightweight, compact design that fits in the palm of your hand – only 2.5 lbs. (1.1kg)
- Offers up to 11 ft. (3.3m) of working capacity
- Quick-activating, high-strength stainless steel braking system
- Corrosion-resistant interior, frame and components
- No annual factory recertification required
- High-impact protective outer cover; visual load indicator
- Available with a variety of integral anchorage connectors
- Rated to 400 lbs. (181.4kg) capacity when using a SofStop shock absorber (928LS/181NYL)

Arrests Free Falls



Model	Description
FL11/11FT	MiniLite without an anchorage connection
FL11-0/11FT	MiniLite with swivel snap hook on web lanyard end
FL11-1/11FT	MiniLite with steel twist-lock carabiner
FL11-2/11FT	MiniLite with stainless steel swivel shackle
FL11-3/11FT	MiniLite with carabiner and swivel shackle
FL11-4/11FT	MiniLite with attached 3' (1m) cross-arm strap*
FL11-5/11FT	MiniLite with locking rebar hook
FL11-6/11FT	MiniLite with rebar hook swivel shackle

Model	Description
FL11-7/11FT	MiniLite with locking snap hook
FL11-8/11FT	MiniLite with snap hook and swivel shackle
FL11-9/11FT	MiniLite (FL11) with no snap hook on the web lanyard end
FL11-10/11FT	MiniLite with swivel shackle (FL11-2) and no snap hook on the web lanyard end
FL11-11/11FT	MiniLite (FL11-6) with rebar hook on web lanyard end
FL11-12/11FT	MiniLite with attached captive-eye carabiner

*Additional lengths available.

Note: Locking Snap Hook – 3/4-inch (19mm) gate opening; Locking Rebar Hook – 2-1/2 inch (63mm) gate opening.

The Miller MiniLite®/Scorpion™/Black Rhino™ Cab Mount Bracket increases overhead clearance in lift truck cabs

- Designed to fit a wide range of lift trucks
- Quick and easy installation
- Non-protruding mount
- Heavy-duty steel construction
- Available in a kit with the Miller MiniLite Fall Limiter (FL11-0/11FT), Scorpion Personal Fall Limiter (PFL-15/9FT) or Black Rhino Self-Retracting Lifeline (CFL-1/9FT)

Model	Description
FL11CMK	Lift Truck Kit (with MiniLite FL11-0 and bracket)
CMB	Bracket only (accommodates MiniLite FL11-0/11FT, Scorpion PFL-15/9FT, Black Rhino CFL-1/9FT)
PFLCMK	Lift Truck Kit (with Scorpion PFL-15/9FT and bracket)
CFLCMK	Lift Truck Kit (with Black Rhino CFL-1/9FT and bracket)

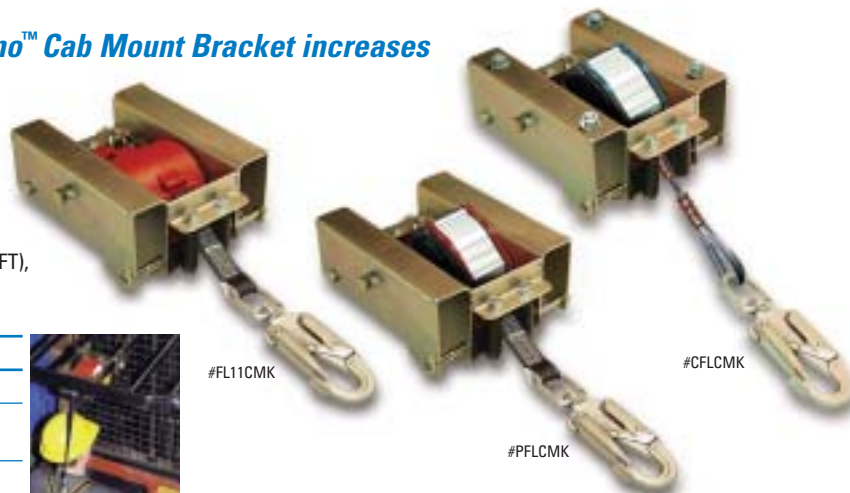

Miller Falcon™ Self-Retracting Lifelines

Nearly indestructible, the high impact-resistant nylon housing withstands the harsh rigors of the toughest applications. The lightest, most rugged line of composite retractables are designed with smooth, round edges to increase durability.

Pound for pound the strongest, most durable retractable. Lifeline available in 20- (6m), 30- (10m), 50- (15m) and 65-ft. (20m) lengths.

- Corrosion-resistant stainless steel and aluminum internal components extend service life and reduce replacement costs
- Lightest composite unit on the market – easy to handle and transport to/from jobsites
- Unique side payout design reduces wear on the entry guide bushing and cable for smooth operation with less drag
- Smooth, quiet operation; engineered spring retraction tension designed not to pull or drag on a worker to improve productivity and reduce fatigue
- Built-in, ergonomically-designed molded handle on the 50- (15m) and 65-ft. (20m) units provide support and leverage when attaching to anchorage connector. Easier to install.
- Dual swivels (unit top and snap hook) included on all models to minimize lifeline from twisting during use
- New and improved load indicator on the snap hook identifies when the unit needs to be removed from service
- **No annual factory recertification required* – lowers cost of ownership and increases productivity**

*Except in Canada where the Canadian Standards Association requires annual factory recertification.

- Rated to 400 lbs. (181.4kg) capacity when using a SofStop shock absorber (928LS/18INYL)

DuraFlex® Harness
#E650-77/UGN



#MP50G/50FT

FALCON™

SELF-RETRACTING LIFELINE

**Xtreme
DURABILITY**



#MP20G/20FT



#MP65G/65FT

**Lifetime
Housing
Guarantee!**
(When used under
typical working conditions.)

Model	Description	Weight	Dimensions (LxWxD)
MP20G/20FT	Miller Falcon 20' (6m) galvanized wire rope (3/16" [5mm]) with tagline and carabiner	8.9 lbs. (4.0kg)	10" x 8.4" x 4" (255mm x 213mm x 101mm)
MP20SS/20FT	Miller Falcon 20' (6m) stainless steel wire rope (3/16" [5mm]) with tagline and carabiner	8.9 lbs. (4.0kg)	10" x 8.4" x 4" (255mm x 213mm x 101mm)
MP30G/30FT	Miller Falcon 30' (10m) galvanized wire rope (3/16" [5mm]) with tagline and carabiner	10.7 lbs. (4.8kg)	10" x 8.4" x 4" (255mm x 213mm x 101mm)
MP30SS/30FT	Miller Falcon 30' (10m) stainless steel wire rope (3/16" [5mm]) with tagline and carabiner	10.7 lbs. (4.8kg)	10" x 8.4" x 4" (255mm x 213mm x 101mm)
MP50G/50FT	Miller Falcon 50' (15m) galvanized wire rope (3/16" [5mm]) with tagline and carabiner	14.8 lbs. (6.7kg)	13.5" x 9.7" x 4" (342mm x 246mm x 101mm)
MP50SS/50FT	Miller Falcon 50' (15m) stainless steel rope (3/16" [5mm]) with tagline and carabiner	14.8 lbs. (6.7kg)	13.5" x 9.7" x 4" (342mm x 246mm x 101mm)
MP65G/65FT	Miller Falcon 65' (20m) galvanized wire rope (3/16" [5mm]) with tagline and carabiner	17.1 lbs. (7.7kg)	13.5" x 9.7" x 4" (342mm x 246mm x 101mm)
MP65SS/65FT	Miller Falcon 65' (20m) stainless steel rope (3/16" [5mm]) with tagline and carabiner	17.1 lbs. (6.7kg)	13.5" x 9.7" x 4" (342mm x 246mm x 101mm)
928LS/18INYL	Miller SofStop shock absorber pack with locking snap hook and D-ring (400 lbs. [181kg] working load when using Falcon SRL)	1.4 lbs. (.6kg)	18" (457mm)

Note: Locking Snap Hook – 3/4-inch (19mm) gate opening; Locking Rebar Hook – 2-1/2 inch (63mm) gate opening.

Miller Technical Support
800/873-5242
www.millerfallprotection.com

Miller Self-Retracting Lifelines

Miller MightyLite Self-Retracting Lifelines

Miller MightyLite Self-Retracting Lifelines (SRLs) are up to 30% lighter than competitive models in their class. Available in 20- (6m), 30- (10m), 50- (15m), 65-ft. (20m), 100- (30m), 130- (40m) and 175-ft. (54m) lengths.

- Durable and dependable, corrosion-resistant stainless steel and aluminum housing
- **No annual factory recertification required*** – lowers cost of ownership and increases productivity
- Ideal for hard-to-mount locations
- Corrosion-resistant stainless steel and aluminum components extend service life
- Carabiner and tagline included**
- Rated to 400 lbs. (181.4kg) capacity when using a SofStop shock absorber (928LS/181NYL)



Cross-Arm Strap
#8183/6FTGN

#RL175G/175FT

#RL20G/20FT

#RL50P/50FT

#RL20G/20FT

Model	Material	Length	Weight
RL20P/20FT	1" (25mm) polyester webbing	20' (6m)	8 lbs. (3.6kg)
RL20G/20FT	3/16" (5mm) galvanized cable	20' (6m)	9 lbs. (4kg)
RL20SS/20FT	3/16" (5mm) stainless steel cable	20' (6m)	9 lbs. (4kg)
RLS30G/30FT	3/16" (5mm) galvanized wire rope	30' (10m)	11 lbs. (5kg)
RLS30S/30FT	3/16" (5mm) stainless steel wire rope	30' (10m)	11 lbs. (5kg)
RL50P/50FT	1" (25mm) polyester webbing	50' (15m)	19 lbs. (8.6kg)
RL50G/50FT	3/16" (5mm) galvanized wire rope	50' (15m)	20 lbs. (9.1kg)
RL50SS/50FT	3/16" (5mm) stainless steel wire rope	50' (15m)	20 lbs. (9.1kg)
RL65G/65FT	3/16" (5mm) galvanized cable	65' (20m)	23 lbs. (10.4kg)
RL65SS/65FT	3/16" (5mm) stainless steel cable	65' (20m)	23 lbs. (10.4kg)
RL100G/100FT	3/16" (5mm) galvanized cable	100' (30m)	40 lbs. (18.1kg)
RL100SS/100FT	3/16" (5mm) stainless steel wire rope	100' (30m)	40 lbs. (18.1kg)
RL130G/130FT	3/16" (5mm) galvanized wire rope	130' (40m)	50 lbs. (22.7kg)
RL130SS/130FT	3/16" (5mm) stainless steel wire rope	130' (40m)	50 lbs. (22.7kg)
RL175G/175FT	3/16" (5mm) galvanized wire rope	175' (54m)	70 lbs. (31.7kg)
RL175SS/175FT	3/16" (5mm) stainless steel wire rope	175' (54m)	70 lbs. (31.7kg)

DuraFlex®
Harness
#E650/UGN

*Except in Canada where the Canadian Standards Association requires annual factory recertification.

Also available **without the carabiner and tagline. To order, add a "B" to the corresponding model number (Ex: RL20BP/20FT).

Notes: Also available with a stainless steel swivel top and stainless steel swivel snap hook. To order, add an "S" to corresponding model number (Ex.: RL20SS-S/20FT). Locking Snap Hook – 3/4-inch (19mm) gate opening; Locking Rebar Hook – 2-1/2 inch (63mm) gate opening.

MightyLite SRL Swivel Bracket

A swivel bracket reduces wear and increases mobility when using a MightyLite Self-Retracting Lifeline. For applications that include leading edge deck construction, warehouse pickers, bridge construction, steel erection and industrial.

- Reduces webbing or cable wear for longer life
- Reduces resistance/drag on worker for increased productivity
- Easy to retrofit on existing MightyLite units for cost savings
- Heavy-duty, zinc-plated steel and stainless steel construction
- Corrosion resistant to withstand the rigorous demands of harsh environments

Model	Description
9082	Swivel bracket (retrofit) for 20' (6m) and 30' (10m) MightyLite units
9083	Swivel bracket (retrofit) for 50' (15m) and 65' (20m) MightyLite units

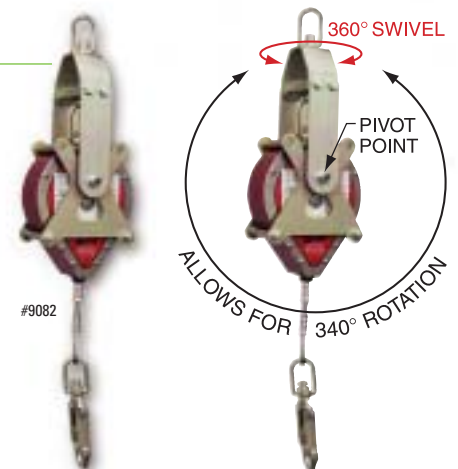

#9082

Miller Welding Products

Fall protection products designed to meet the challenges of welding environments. Available in Lightweight/Comfort and Heavy-Duty Harness models, Miller welding products also include a variety of connecting devices and anchorage connectors.

Lightweight/Comfort Welder Harness

- A complete line of lightweight, comfort welder harnesses features blue, flame-retardant Nomex® webbing to protect against weld splatter
- The special inner Kevlar® core adds strength and high-temperature resistance
- Contrasting webbing colors make inspection easier
- Rated to 400 lbs. (181.4kg) capacity when using a SofStop shock absorber (940K/6FTBL)

Heavy-Duty Welder Harness

- Designed with rugged black Kevlar® webbing to withstand harsh welding environments
- Meets ASTM F887 Arc Test requirements and are rated for arc exposure
- All models feature quick-connect buckles on the chest strap for easy/fast donning
- Rated to 400 lbs. (181.4kg) capacity when using a SofStop shock absorber (940K/6FTBL)

All welding harnesses include unique, durable Lexan® labeling with inspection grid for easy tracking. Model numbers listed are for universal size. Harnesses are also available in small/medium and XXL large, by replacing the "U" in the model number with "S/M" or "XXL".



Model	Sizes	Back D-Ring	Front D-Ring	Side D-Rings	Shoulder Strap Buckles	Leg Strap Buckles	Chest Strap Buckle	Sub-Pelvic Strap	Special Features
Lightweight/Comfort Harnesses									
650K/UBL	U	Yes	Option	No	Friction	Mating	Mating	Yes	Belt loops; pull-up adjustment
650K-7/UBL	U	Yes	Option	Yes	Friction	Mating	Mating	Yes	Belt loops; pull-up adjustment
751K/UBL	U	Yes	Option	No	-	Mating	Mating	Yes	-
850K/UBL	U	Yes	No	No	Friction	Mating	Mating	Yes	Pull-down adjustment
Heavy-Duty Harnesses									
850KQC/UBK	U	Yes	Option	No	Friction	Quick-Connect	Quick-Connect	Yes	Pull-down adjustment
850KQC-4/UBK	U	Yes	Option	No	Friction	Tongue	Quick-Connect	Yes	Pull-down adjustment
850KQC-58/UBK	U	Yes	Option	Yes	Friction	Tongue	Quick-Connect	Yes	Pull-down adjustment
650KQC-4/UBK	U	Yes	Option	No	Friction	Tongue	Quick-Connect	Yes	Pull-up adjustment
650KQC-58/UBK	U	Yes	Option	Yes	Friction	Tongue	Quick-Connect	Yes	Pull-up adjustment

Welding Lanyards

Model	Material	Two Legged	Harness Connection	Anchorage Connection	Standard Length	Special Features
907K/6FTBL	1/4" (6mm) wire rope	No	Locking snap hook	Locking snap hook	6' (1.8m)	SofStop shock absorber with Nomex cover and Kevlar core
913K/6FTBL	Nomex/Kevlar webbing	No	Locking snap hook	Locking snap hook	6' (1.8m)	
940K/6FTBL	Nomex/Kevlar webbing	No	Locking snap hook	Locking snap hook	6' (1.8m)	
947K/6FTBL	1/4" (6mm) wire rope	No	Locking snap hook	Locking snap hook	6' (1.8m)	Double SofStop Pack shock absorber for 12' (3.6m) free fall with Nomex cover and Kevlar core (use w/Miller Shadow Beam Anchor)

Black Rhino Self-Retracting Lifeline (for a complete listing of Black Rhino SRL models, see page 21)

Model	Cable Lifeline Length	Anchorage Connection	Connection to Harness	Weight
CFL-1/9FT	9' (2.7m)	None (need carabiner, not included)	Locking, swivel snap hook with load indicator	4.8 lbs. (1.9kg)

Shadow Beam Anchor (for a complete listing of Shadow Beam Anchor models, see page 31)

Model	Description	Fits Flange Size
8814-12	Lightweight, adjustable Shadow Beam Anchor – stainless steel and high-strength aluminum	4" to 12" (100mm to 305mm)
8815-12	Lightweight, fixed Shadow Beam Anchor – stainless steel and high-strength aluminum	4" to 12" (100mm to 305mm)
8815-24	Lightweight, fixed Shadow Beam Anchor – stainless steel and high-strength aluminum	12" to 24" (305mm to 610mm)
8816-14	Lightweight, adjustable ShadowLite Beam Anchor – high-strength aluminum	3" to 14" (96mm to 355mm)
8814-24	Adjustable Shadow Beam Anchor – stainless steel and high-strength aluminum	12" to 24" (30mm to 610mm)

Anchorage Connector

8185K/6FTBL	6' (1.8m) Nomex/Kevlar webbing cross-arm strap with D-ring and loop; available in lengths from 4' (1.2m) to 10' (3m)
-------------	--



#8477HG1/BL



#8816-14

Accessories

8477HG1/BL	Durable MillerHyde bag w/heavy-duty zipper closure and strong wrap-around carrying strap
------------	--

Nomex® and Kevlar® are registered trademarks of E.I. DuPont.

Miller Technical Support
800/873-5242
 www.millerfallprotection.com

Miller Positioning & Restraint Lanyards

Rope, wire rope and web lanyards are recommended for "work positioning" and "restraint" only.



Rope lanyards are available in standard nylon or polyester (for greater chemical resistance) to meet user needs.



Wire rope lanyards are heat resistant and highly abrasion resistant.



Standard nylon web lanyards are economical, abrasion resistant and easy to clean. Also available in polyester webbing for greater chemical resistance.

Model	Material	Harness Connection	Anchorage Connection	Special Features	Standard Length*
198RLS-2/6FTWH**	Nylon rope	Choke-off loop	Locking snap hook	-	6' (1.8m)
201RLS-2/6FTWH**	Nylon rope	Locking snap hook	Locking snap hook	-	6' (1.8m)
202RRS-2/6FTWH**	Nylon rope	Locking snap hook	Locking rebar hook	-	6' (1.8m)
203RLS-2/6FTWH**	Nylon rope	Locking snap hook	Locking snap hook	Adjustable	6' (1.8m)
204RLS-2/6FTWH**	Nylon rope	Locking snap hook	Thimble for attaching a carabiner	-	6' (1.8m)
207LS/6FTG	Wire rope	Locking snap hook	Locking snap hook	-	6' (1.8m)
207NLS/6FTV	Vinyl-coated wire rope	Locking snap hook	Locking snap hook	-	6' (1.8m)
210WLS/6FTYL***	Nylon webbing	Locking snap hook	Locking snap hook	Adjustable	6' (1.8m)
212WLS/6FTYL***	Nylon webbing	Locking snap hook	Web loop	-	6' (1.8m)
213WLS/6FTYL***	Nylon webbing	Locking snap hook	Locking snap hook	-	6' (1.8m)
226WRS/6FTYL***	Nylon webbing	Locking snap hook	Locking rebar hook	-	6' (1.8m)

*Additional lengths are available.

**To order polyester rope, add "-5" to the corresponding model number. (Ex.: 201RLS-2 becomes 201RLS-5).

***To order polyester webbing, add a "D" after the "W" in the corresponding model number. (Ex.: 210WLS becomes 210WDLS).

Note: Locking Snap Hook - 3/4-inch (19mm) gate opening; Locking Rebar Hook - 2-1/2 inch (63mm) gate opening.

Miller Positioning Assemblies



New Improved Design!



Model	Description
6756RS	13-link rebar chain assembly with two locking snap hooks and one locking rebar hook; swivel attachment and length adjuster
6756RS4	4-link rebar chain assembly with two locking snap hooks and one locking rebar hook; swivel attachment
6757WRS*	1" (25mm) nylon web positioning assembly with two locking snap hooks and one locking rebar hook

*Must specify webbing length of 27 inches (685mm) or 35 inches (889mm).

Note: Locking Snap Hook - 3/4-inch (19mm) gate opening; Locking Rebar Hook - 2-1/2 inch (63mm) gate opening.



Miller Rope Grabs

Miller rope grabs move easily up and down vertical lifelines to provide continuous fall protection. Trailing models offer complete hands-free operation for increased productivity. In the event of a fall, Miller rope grabs lock quickly.

- Compact design; corrosion-resistant stainless steel construction
- Lightweight and easy to use



Model	Description
8172*	MicroLoc™ stainless steel, compact, trailing wire rope grab for use with 5/16" (8mm) wire rope
8173*	MicroLoc™ stainless steel, compact, trailing rope grab for use with 5/8" (16mm) rope
8174	Stainless steel, manual rope grab for use with 5/8" (16mm) or 3/4" (19mm) synthetic rope
8174MLS/4FTYL	8174 with attached 4' (1.2m) Manyard shock-absorbing lanyard with locking snap hook
8174RLS/2FTWH	8174 with attached 2' (.6m) rope lanyard with locking snap hook
8174WLS/2FTYL	8174 with attached 2' (.6m) web lanyard with locking snap hook
98174LS/3FTYL	8174 with attached SofStop shock-absorber with locking snap hook
8175	Stainless steel trailing rope grab for use with 5/8" (16mm) rope
8175RLS/2FTWH	8175 with attached 3' (1m) rope lanyard with locking snap hook
8175WLS/3FTYL	8175 with attached 3' (1m) web lanyard with locking snap hook
8175SLS/3FTYL	8175WLS with SofStop shock-absorber with locking snap hook

*Does not meet CSA requirements.
Note: Locking Snap Hook – 3/4-inch (19mm) gate opening.

DuraFlex®
Harness
#E650/UGN

#8175SLS/3FTYL



Miller Vertical Lifelines

Miller rope grabs are designed for use with 5/8-inch (16mm) synthetic rope lifeline with a minimum tensile strength of 5,000 lbs. (22kN), secured to an anchorage independent of the worker's platform. Standard lifeline lengths are 25 feet (7.6m), 50 feet (15m), 75 feet (23m), and 100 feet (30m); additional lengths are available.

Wire rope grabs are designed for use with 5/16-inch (8mm) galvanized or stainless steel wire rope lifelines.

Model*	Description
194R-2	Nylon rope lifeline with carabiner and thimble; 5/8" (16mm) diameter
194R-5	Polyester rope lifeline for greater chemical resistance with carabiner and thimble; 5/8" (16mm) diameter
195R-2	Nylon rope lifeline with thimbles; 5/8" (16mm) diameter
195R-5	Polyester rope lifeline for greater chemical resistance with thimbles; 5/8" (16mm) diameter
300L	Polyester/polypropylene blend rope lifeline with locking snap hook and loop; 5/8" (16mm) diameter

*Must specify length when ordering.

Miller Temporary Anchorage Connectors

Anchorage Connectors are designed as the intermediary for securing a connecting device to an anchorage. Careful consideration should be given to selecting a proper anchorage for ultimate safety. The anchorage should be easily accessible, located a safe distance above any lower obstacles and support 5,000 lbs. (22kN) per worker.

Miller Grip™ Anchorage Connectors

Portable/reusable anchorage connectors designed for use in concrete applications.

- A **safe anchor point** is established when the Miller Grip anchor is inserted into a properly-sized, cured concrete hole
- The **reusable Miller Grip anchor** can be removed and simply re-installed in a new location
- Designed for **vertical or overhead/ceiling surface applications**
- Model 497 can be used with SkyWalker Horizontal Lifeline components for a two-person system (see DF497 Kit on page 35 for details)
- Multi-use Grips can be used for anchoring scaffolding, material handling and removal of concrete debris after demolition
- Constructed of stainless steel, aluminum and other non-corrosive materials for a **longer service life**
- **Designed for use in cured concrete** with a compression strength of at least 3,000 psi
- **Color-coded** to differentiate *fall protection* (models 496 & 497 are green) and *multi-use* (Models 498 & 499 are silver) per OSHA regulations



#496



Model	Size	Description
496	3/4" (19mm)	5,000 lb. (2268kg) capacity for single user connection; 400 lbs. (181.4kg) maximum capacity
497	1" (25mm)	10,000 lb. (4536kg) capacity for single user connection; 400 lbs. (181.4kg) maximum capacity
498	3/4" (19mm)	1,000 lb. (453.6kg) max. safe working load for multi-use connection (NOT for fall protection use)
499	1" (25mm)	2,000 lb. (907.2kg) max. safe working load for multi-use connection (NOT for fall protection use)

Miller Grip™ Friction Bolt Anchorage Connectors

The portable/reusable anchorage connector is designed exclusively for use with a Friction Bolt.

- A **safe anchor point for a single user** is established when the Miller Grip anchor (Model 494) is inserted into a **friction bolt** with an outside diameter of 1.5 inches (39mm)
- **Multiple applications:** Mine shafts, railway or road tunnels and underground storage caverns
- The **reusable Miller Grip anchor** can be removed and simply re-installed in a new location
- Constructed of stainless steel, aluminum and other non-corrosive materials for a **longer service life**

Model	Weight	Description
494	1 lb. (.5kg)	Grip anchor for single user 400 lbs. (181.4kg) maximum capacity, designed exclusively to accommodate a friction bolt with an outside diameter of 1.5 inches (39mm)
DF494/60FT	60' (18.3m)	SkyWalker wire rope lifeline and two Miller Grip anchorage connectors (Model 494) to accommodate two friction bolts with outside diameters of 1.5 inches (39mm)



Temporary Anchorage Connectors

Push-Thru Eye Bolt



Spring-action anchorage connector offers simple one-hand installation and can be used for a wide range of applications. Fits 3/4 inches (19mm) dia. holes and includes the integral SofStop Shock Absorber. 400 lbs. (181.4kg) maximum capacity. **Model 420**

Rebar Hook Anchor



Designed to facilitate anchoring to scaffolding, pipe or angle iron, and features a locking rebar hook with SofStop Shock Absorber and a D-ring on the other end to accommodate the connecting device. 400 lbs. (181.4kg) maximum capacity. **Model 485/22INYL**

Rebar Hook Anchor



Designed to facilitate anchoring to scaffolding, pipe or angle iron, and features a locking rebar hook for easy, one-hand installation and a D-ring on the other end to accommodate the connecting device. 400 lbs. (181.4kg) maximum capacity. **Model 480/19INGN**

Wire Hook



Stainless steel Wire Hook connects to various approved anchorages including railings, small I-beams, angle iron and scaffolding. Simply squeeze the spring-loaded hook and slip the large opening over the approved structure. 400 lbs. (181.4kg) maximum capacity. **Model 470**

Cross-Arm Strap



6 ft. (1.8m) web Cross-Arm Strap wraps around I-beams and other structures and attaches with a 2-inch (50mm) D-ring that slips through a 3-inch (76mm) D-ring to form a secure attachment point for lanyards and other connecting devices. 400 lbs. (181.4kg) maximum capacity. **Model 8183/6FTGN**

Beam Trolley



The Beam Trolley is adjustable and slides along with the worker to provide maximum mobility. The lightweight Beam Trolley Retrofit Kit (**Model 9065**) adjusts to fit beam flanges from 3-inch (76mm) to 4-1/2 inches (114mm) wide. **Model 9065-1** accommodates I-beams up to 8-1/2 inches (216mm) wide. **Model 9065-2** accommodates I-beams up to 12-inches (305mm) wide. 400 lbs. (181.4kg) maximum capacity.

Extension Pole & Hook



The 20 ft. (6m) fiberglass pole and spring-loaded hook is ideal for climbing ladders and towers. Installs fall arrest systems up to 20 ft. (6m) from ground level to angle iron, piping and related structures. 400 lbs. (181.4kg) maximum capacity. **Model 475**

Cross-Arm Chain



The 6 ft. (1.8m) Chain Cross-Arm provides a single user with an easy-to-install, temporary anchorage connector. It easily wraps around I-beams or other structures. This product safely wraps around corners and sharp edges and is ideal to use in environments where chemical, heat or welding splatter may occur. 400 lbs. (181.4kg) maximum capacity. **Model 440/6FT**

Looped Cross-Arm Strap



The 6 ft. (1.8m), 2-inch (50mm) webbing strap features a 2-inch (50mm), D-ring which slips through looped webbing. 400 lbs. (181.4kg) maximum capacity. **Model 8185/6FTGN**

Beam Clamps



The Beam Clamp is a steel anchor point that can be attached to horizontal I-beams, S-beams or W-beams. Its swivel attachment ring prevents twisting of the worker's connecting device. **Model 450** accommodates beams with a maximum width of 9 inches (229mm). **Model 455** accommodates beams with a maximum width of 12-1/2 inches (318mm). 400 lbs. (181.4kg) maximum capacity.

Concrete Form Anchor

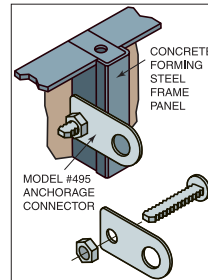

The Concrete Form Anchor is designed to attach to existing holes in concrete forming steel frame panels. Installs easily by inserting the shaft of the connector through the slots in the form and tightening the nut. **Model 495**

Temporary Anchorage Connectors (continued)

Concrete D-Bolt



Concrete D-Bolt Anchorage Connector (**Model 417C**) includes a 5/8-inch (16mm) stud-type expansion anchor that is ideal

for applications with concrete and lightweight concrete that meet required specifications (min. 2,000 psi). Can be installed on a vertical wall or overhead for versatility. Concrete Expansion Bolt (**Model 417CBOLT**) available separately.

Cable Anchor

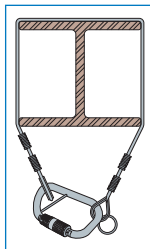

Cable Anchorage Connectors create quick and easy secure points of attachment. Constructed of 1/4-inch (6mm) vinyl-coated, galvanized wire rope and a steel 3-inch (76mm) O-ring. Standard length is 6 ft. (1.8m); additional lengths available. **Model 8187V** features a forged steel, auto-lock, captive eye carabiner with 1-inch

(25mm) gate opening. **Model 8186V** features a locking snap hook with 3/4-inch (19mm) gate opening. 400 lbs. (181.4kg) maximum capacity.

Disposable Concrete Anchor Strap



The Disposable Concrete Anchor Strap is uniquely designed to provide temporary anchorage on concrete forms.

Constructed of 1-3/4 inch (44mm) wide, abrasion-resistant webbing. Forged steel D-ring (**Model 8185C**) is capable of withstanding 5,000 lbs. (22kN). Standard lengths of 2 ft. (.6m) and 4 ft. (1.2m); additional lengths available. Also available with web loop (includes inner-wear pad for carabiner attachment) **Model 8185CX**.

Carabiners

400 lbs. (181.4kg) maximum capacity.



Steel twist-lock carabiner; 1-inch (25mm) gate opening. **Model 17D-1**



Lightweight, aluminum twist-lock carabiner; 1-inch (25mm) gate opening. **Model 17D-2**



Triple-action twist-lock carabiner. Lightweight aluminum; 1-inch (25mm) gate opening. **Model 17D-3**



Large, steel twist-lock carabiner; 2-inch (50mm) gate opening. **Model 18D-1**



Large, aluminum twist-lock carabiner; 2-1/4 inch (57mm) gate opening. **Model 18D-2**

Miller Permanent Anchorage Connectors

Anchorage Connectors are designed as the intermediary for securing a connecting device to an anchorage. Careful consideration should be given to selecting a proper anchorage for ultimate safety. The anchorage should be easily accessible, located a safe distance above any lower obstacles and support 5,000 lbs. (22kN) per worker. 400 lbs. (181.4kg) maximum capacity.

Mounted D-Ring



Steel D-ring with plate, complete with 4-3/8 inch (9.5mm) diameter bolts, lockwashers, nuts and drilling template. **Model 410**

D-Bolt Anchor



1/2-inch (13mm) diameter D-bolt; 1-1/4 inch (32mm) long; one-piece unit with lockwasher and nut. **Model 415**

D-Bolt Anchor



D-Bolt Anchor (**Model 416**) for up to 4-inch (100mm) working thickness includes a 5/8-inch (16mm) diameter bolt with lockwasher and nut. D-Bolt Anchor w/o hardware (**Model 417**) sold separately.

Miller Edge™ Fall Protection System



The first and only cost-effective, portable, engineered anchorage solution designed to protect workers engaged in leading edge deck construction. The Miller Edge reduces the need for a safety monitor or a temporary cable lifeline system on leading edge deck construction.

- Freestanding, mobile overhead anchor point
- Solid Althane™ wheel casters
- Two integral eye bolt attachment points accommodate self-retracting lifelines
- Predetermined integral lifting points
- Heavy-duty steel construction with protective enamel paint
- Easy access handles on front and rear
- Redundant braking system



Applications

- Concrete deck construction
- Bridge decks
- Window washing
- Vault entry
- Rescue situations

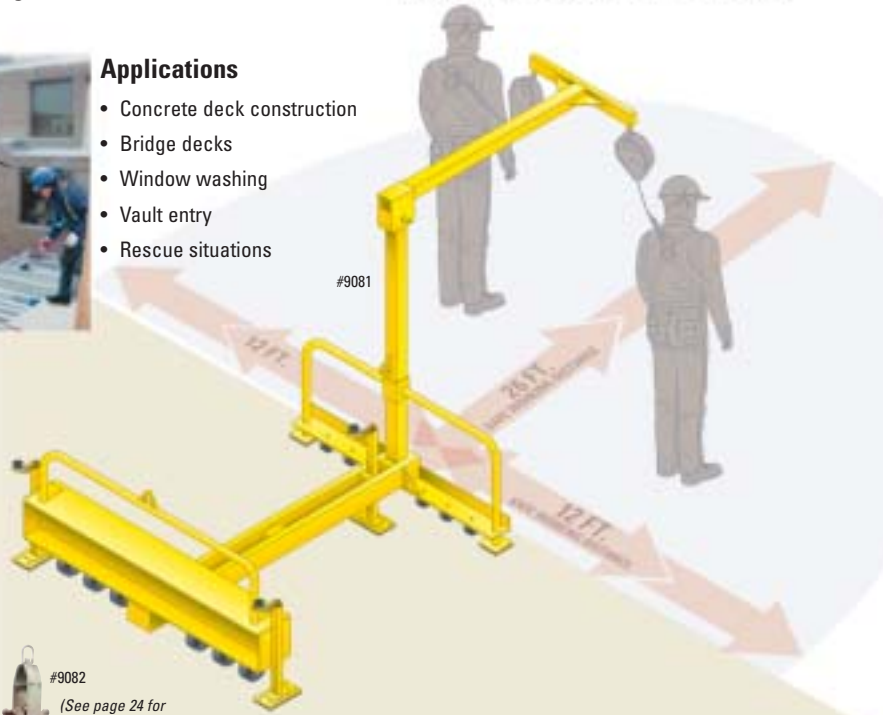

Model	Description
9081	Standard Miller Edge with 7-1/2' (2.3m) anchorage height
9081/6.5FT	Miller Edge with 6-1/2' (2m) anchorage height
9081/9.5FT	Miller Edge with 9-1/2' (2.9m) anchorage height; includes 300 lbs. (136kg) additional counterweight required
9081/VBK-9.5	9-1/2' (2.9m) height conversion kit; includes 9081/VB-9.5 and 9081WT/300LB; converts a Standard Edge System (9081) into a 9-1/2' (2.9m) high anchorage system
9081/VB-9.5	Vertical boom for 9-1/2' (2.9m) high Edge System; boom measures 108" (274cm)
9081/VB-6.5	Vertical boom for 6-1/2' (2m) high Edge System; boom measures 72" (183cm)
9081WT/300LB	Set of 300 lb. (136kg) counterweights required for 9-1/2' (2.9m) high Edge System
9081MRMB	MightEvac Bracket for Edge System; holds 1 or 2 units (MightEvac units, brackets and pulleys sold separately)

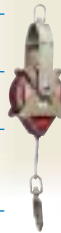

#9082
(See page 24 for additional information.)

Model	Description
9082	Swivel Bracket (retrofit) for 20' (6m) and 30' (10m) MightyLite SRL units (optional)
9083	Swivel Bracket (retrofit) for 50' (15m) and 65' (20m) MightyLite SRL units (optional)

Miller Shadow® Beam Anchors

Miller Shadow Beam Anchors connect horizontally to a wide range of I and H beam flanges from 3 inches (76mm) to 24 inches (610mm) wide and up to 2-1/2 inches (63mm) thick. Once attached, the units (Models 8811, 8814, and 8816) slide along the beam with the worker to provide increased safety, mobility and productivity. The fixed unit (Model 8815) is designed to be tightened horizontally or vertically, firmly gripping the beam or column to provide a temporary or permanent anchorage attachment.

Model	Description	Fits Flange Sizes
8811	Shadow Beam Anchor only – 100% steel construction	5" to 12" (127mm to 305mm)
8812	Shadow Beam Anchor (8811) w/SofStop Shock Absorber	5" to 12" (127mm to 305mm)
8814-12	Lightweight, adjustable Shadow Beam Anchor – stainless steel and high-strength aluminum	4" to 12" (100mm to 305mm)
8814-24	Lightweight, adjustable Shadow Beam Anchor – stainless steel and high-strength aluminum	12" to 24" (305mm to 610mm)
8815-12	Lightweight, fixed Shadow Beam Anchor – stainless steel and high-strength aluminum	4" to 12" (100mm to 305mm)
8815-24	Lightweight, fixed Shadow Beam Anchor – stainless steel and high-strength aluminum	12" to 24" (305mm to 610mm)
8816-14 New!	Lightweight, adjustable ShadowLite Beam Anchor – high-strength aluminum; 4.2 lbs. (2kg)	3" to 14" (76mm to 355mm)
940WLS/6FTGN	6' (1.8m) shock-absorbing web lanyard* with Double SofStop pack, two locking snap hooks (designed for 12 ft. [3.7m] fall – use with beam anchors)	

*For greater chemical-resistant blue webbing, substitute "BL" for "GN" in the suffix of the corresponding lanyard model number (Ex: 940WLS/6FTBL).

Welder Harness
#650K/UBL



Miller Roof Systems

ReadyRoofer® Fall Protection System

Lightweight, Full-Body Harness

- Fully-adjustable, non-stretch harness

Versatile, Reusable Roof Anchor w/Attachment D-Ring

- Easily installs on steep-pitched or flat-surface roofs
- Reusable roof anchor

Compact Trailing Rope Grab

- Durable, corrosion-resistant, stainless steel construction
- Attaches anywhere on the lifeline
- Lightweight, easy-to-use design with hands-free operation

Shock-Absorbing Lanyard

- 3 ft. (.9m) polyester web lanyard with integral shock absorber and two locking snap hooks

High-Strength Rope Lifeline

- 5/8-inch (16mm) diameter polyester/polypropylene rope with loop and locking snap hook
- 9,300 lb. tensile strength, treated to combat ultraviolet rays

Water-Proof Container

- Ideal for equipment storage



#BRFK50/50FT

Model	Description
BRFK25/25FT	Kit w/25' (7.6m) rope lifeline
BRFK50/50FT	Kit w/50' (15m) rope lifeline
BRFK75/75FT	Kit w/75' (23m) rope lifeline
BRFK100/100FT	Kit w/100' (30m) rope lifeline

RoofStrider Systems



#RM50P/50FT



#SRM30G/30FT

RoofStrider II Kit

- MightyLite self-retracting lifeline w/360° rotating bracket
- Roof mounting assembly w/clamping feet for use on standing seam metal roofs

RoofStrider Kit

- MightyLite self-retracting lifeline w/360° rotating bracket
- Roof mounting assembly for variable pitch wood roofs (roof peaks or flat sides), most ridge vents, studs, joists, etc.
- Hardware included for mounting on wood roofs and metal decking

RoofStrider Systems (includes DuraFlex stretchable harness Model E850/UGN, instructional video & carrying bag)

RM50P/50FT	Complete system w/50' (15m) MightyLite SRL w/webbing
RM50G/50FT	Complete system w/50' (15m) MightyLite SRL w/galvanized wire rope

RoofStrider II Systems (includes SofStop shock absorber Model 928LS/18INYL)

SRM30G/30FT	Complete system w/30' (10m) MightyLite SRL w/galvanized wire rope
SRM50P/50FT	Complete system w/50' (15m) MightyLite SRL w/webbing
SRM50G/50FT	Complete system w/50' (15m) MightyLite SRL w/galvanized wire rope
SRM65G/65FT	Complete system w/65' (20m) MightyLite SRL w/galvanized wire rope

RoofStrider II Parts and Accessories

SRM	Roof mounting assembly w/clamping feet
SRMF-1	Clamping feet w/hardware for standing seam metal roofs
SRMF-2	Feet and hardware for wood or metal decking

Temporary Roof Anchors



RA10-1

- 12 single use with nails



RA15-1

- 10 reusable anchors
- D-rings, screws



RA20-1

- 2 reusable anchors with screws



RA30-1

- Reusable; steep-pitched or flat roof



RA35-1

- Reusable; flat surfaces



17D-1

- Steel, auto-locking carabiner

Carabiner

Miller Permanent Roof Anchors

Permanent roof anchorages designed for residential and commercial construction.

MILLER SINGLE PERMANENT ROOF ANCHOR

- The Single D permanent roof anchor is designed to provide one (1) D-ring anchorage point when securely installed on a wood roof sub-surface or vertical wall
- Stainless steel construction; plated steel D-ring
- Accommodates single user for fall protection



MILLER DOUBLE PERMANENT ROOF ANCHOR

- The Double D permanent roof anchor is designed to provide two (2) D-ring anchorage points when securely installed on a wood roof sub-surface
- Stainless steel construction; two plated steel D-rings
- Accommodates single user for fall protection

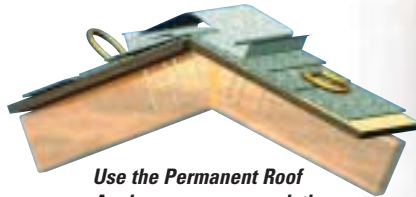

Use the Permanent Roof Anchors on new or existing roofs to provide a quick, safe anchorage point.

Single D Roof Anchors can also be used for vertical applications.

Model	Description
RA41	Stainless steel permanent single D-ring roof anchor over a wood ridge peak. Complete with 8, 16d nails.
RA40	Stainless steel permanent double D-ring roof anchor over a wood ridge peak. Complete with 8, 16d nails.

MILLER Claw PERMANENT ROOF ANCHOR

- The Claw permanent roof anchor is designed to provide a single anchorage point when securely installed on a wood rafter or truss member. The Claw anchor fits wood sizes 2" x 4", 2" x 6", 2" x 8", 2" x 10" or 2" x 12".
- Stainless steel construction
- Accommodates single user for fall protection



Model	Description
RA45	Stainless steel permanent roof anchor over wood rafter/truss members. Complete with UV-resistant *Santoprene® flashing, protective cap and 12, 1-1/2" nails.

*Santoprene® is a registered trademark of Monsanto Corporation.

Miller Roofing Kits

Miller Roof Anchor Kits are easy to use and install on steep-pitched or flat-surface roofs.

- 12 single-use or two reusable roof anchors
- Steel twist-lock carabiner
- Nylon rope lifeline
- Manual stainless steel rope grab with 2 ft. (.6m) webbing lanyard with shock-absorber
- DuraFlex Stretchable Harness (Model E850/UGN)

Model	Description
RA10-25/25FT	Kit w/single-use roof anchors and 25' (7.6m) rope lifeline
RA10-50/50FT	Kit w/single-use roof anchors and 50' (15m) rope lifeline
RA20-25/25FT	Kit w/reusable roof anchors (RA10-1) and 25' (7.6m) rope lifeline
RA20-50/50FT	Kit w/reusable roof anchors (RA20-1) and 50' (15m) rope lifeline



Temporary Lifelines

Miller Horizontal Lifeline Systems

Miller SkyWalker™ Temporary Horizontal Lifelines

The Miller SkyWalker Temporary Horizontal Lifeline adds a new dimension to fall protection versatility. The SkyWalker System offers continuous fall protection for the length of the lifeline. It is ideal for applications where an overhead anchorage does not exist. Systems up to 300 ft. (91m) available.

I-Beam Installation

- Intermediate stanchions permit worker to pass without disconnecting from the lifeline — 100% tie-off
- Lightweight anchorages (stanchions), (approx. 40 lbs. [18kg] each) for easy one-person installation and handling — no tools required for stanchion installation
- Unique engineering design for I-beam installation allows worker to immediately attach to the lifeline eliminating fall hazards

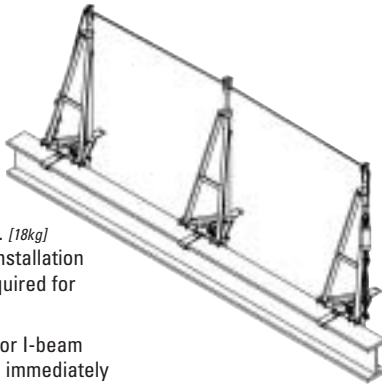

Concrete Installation

- Same features as I-beam installation
- Attaches to rebar
- Attaches to single-flared coil inserts (Dayton/Richmond B-18-3/4" x 6")

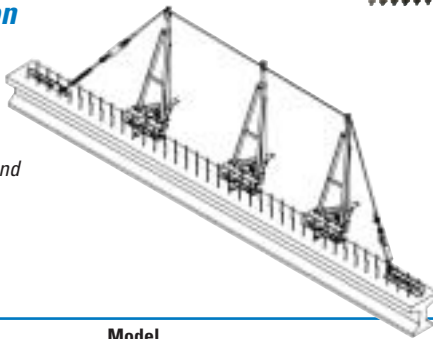

Model (For beam flanges 4" [101mm] to 18" [457mm] wide up to 1.5" [38mm] thick)	Model (For beam flanges 6" [152mm] to 24" [610mm] wide up to 2.5" [64mm] thick)	Length	Description
DFA18/30FT	DFA24/30FT	30' (9m)	Single-span SkyWalker System; accommodates two workers
DFA18/60FT	DFA24/60FT	60' (18.3m)	Single-span SkyWalker System; accommodates two workers
DFB18/100FT	DFB24/100FT	100' (30.5m)	Multiple-span SkyWalker System; with one intermediate support anchorage; accommodates four workers
DFB18/200FT	DFB24/200FT	200' (61m)	Multiple-span SkyWalker System; with three intermediate support anchorages; accommodates five workers
DFB18/300FT	DFB24/300FT	300' (91m)	Multiple-span SkyWalker System; with five intermediate support anchorages; accommodates five workers

Additional SkyWalker System Attachments Required for Concrete Applications

Model	Description
DFPCA	Two tie-back anchor brackets and shock absorber (one DFPCA kit required per system)
DFPCB	One bracket adapter required for each anchorage (number of DFPCB bracket adapters required based on total number of anchorages in system, including end and intermediate anchorages)

Note: SkyWalker System replacement components may be ordered separately. Contact Miller Customer Service at 800/873-5242.

Miller SkyWalker™ Wire Rope Lifeline Kits

A Miller SkyWalker Wire Rope Lifeline may be used in conjunction with approved Miller brand anchorage connectors to provide a temporary horizontal lifeline system that is quick and easy to install.

SkyWalker Kits:

- **Miller D-Bolt Anchors** may be installed to approved structures to provide a temporary or permanent anchorage
- **Miller Grip Anchors** may be used in concrete substrate or mining friction bolts to provide secure points of attachment
- **Miller Cross-Arm Straps** conveniently wrap around I-beams and other structures to form secure points of attachment
- **Miller Fixed Beam Anchors** connect both horizontally and vertically to beams or columns. A durable, spring-loaded, positive-lock engagement pin ensures proper installation.

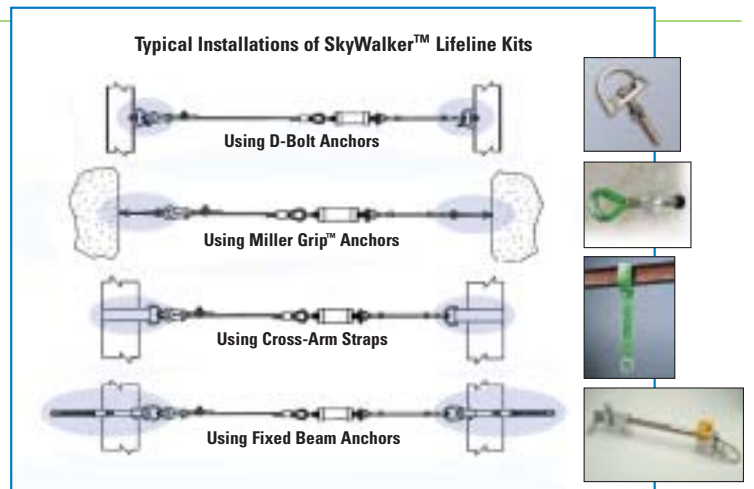

Model	Length	Description
DF416/60FT	60' (18.3m)	SkyWalker wire rope lifeline and two D-bolt anchors (Model 416); includes 5/8" (16mm) diameter bolt with lockwasher and nut for up to 4" (102mm) working thickness
DF417/60FT	60' (18.3m)	SkyWalker wire rope lifeline and two D-bolt anchors (Model 417); bolt not included
DF494/60FT	60' (18.3m)	SkyWalker wire rope lifeline and two Miller Grip anchorage connectors (Model 494) to accommodate two <i>friction bolts</i> with outside diameters of 1.5 inches (39mm)
DF497/60FT	60' (18.3m)	SkyWalker wire rope lifeline and two Miller Grip (Model 497) anchorage connectors
DF8183-6/60FT	60' (18.3m)	SkyWalker wire rope lifeline and two 6' (6.1m) cross-arm straps (Model 8183/6FTGN)
DF8183-20/60FT	60' (18.3m)	SkyWalker wire rope lifeline and two 20' (1.8m) cross-arm straps (Model 8183/6FTGN)
DF8815-12/60FT	60' (18.3m)	SkyWalker wire rope lifeline and two fixed beam anchors (Model 8815-12); fits beam flanges 4" (102mm) to 12" (305mm) wide up to 1.5" (38mm) thick
DF8815-24/60FT	60' (18.3m)	SkyWalker wire rope lifeline and two fixed beam anchors (Model 8815-24); fits beam flanges 12" (305mm) to 24" (610mm) wide up to 2.5" (64mm) thick

Note: SkyWalker Wire Rope Lifeline Kits include the Xtreme™ inline shock absorber, turnbuckle, combination clamp and thimble, anchor shackle, and wire rope clip.

Miller Temporary Horizontal Lifeline Systems

Suspended between two approved anchor points, the Miller Temporary Horizontal Lifeline System permits one worker to freely travel horizontal distances up to 60 ft. (18m) to perform an array of construction, maintenance or inspection activities.

The system includes: 5/8-inch (16mm) polyester rope lifeline and lifeline tensioner, anchoring lanyard, convenient carrying bag.

Model	Description
RHL30/30FT	Temporary horizontal lifeline system with span of 30' (9m)
RHL60/60FT	Temporary horizontal lifeline system with span of 60' (18m)
9031	Lifeline tensioner
9032	Anchoring lanyard
199RLS-5/30FTWH	30' (9m) polyester rope lifeline
199RLS-5/60FTWH	60' (18m) polyester rope lifeline

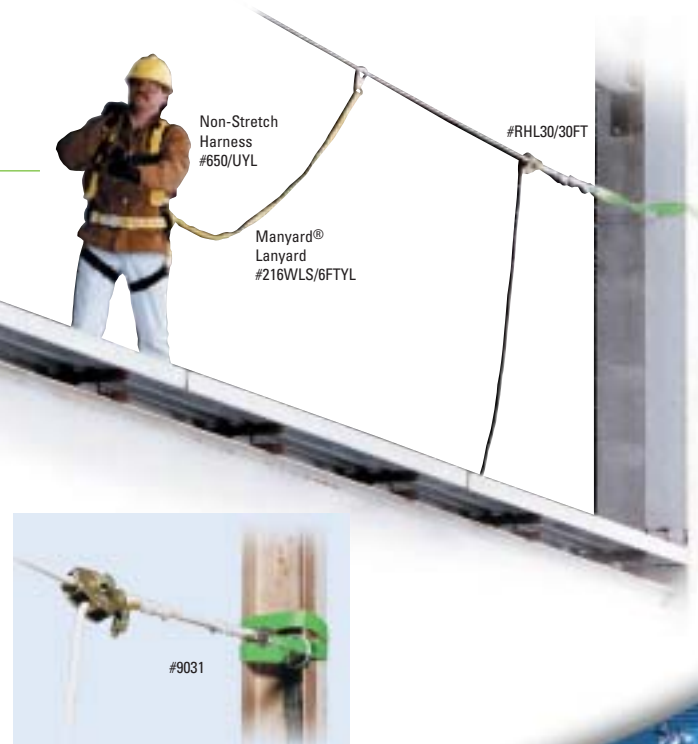

Miller Vertical Climbing Systems

Söll Xenon® Permanent Horizontal Lifeline Systems

Whether it's along a rooftop, inside an arena or high atop a suspension bridge, the Söll Xenon Permanent Horizontal Lifeline System provides "hands-free" fall protection for a variety of configurations: straight or curved; multiple bends; floors; ridgelines or frontal posts. A uniquely-designed shuttle connector automatically bypasses intermediate supports without disconnecting from the lifeline, increasing mobility and promoting worker safety.

Because of its versatility, simplicity and minimal maintenance, a Xenon System is the perfect solution for engineers, architects and contractors to provide secure safety access on new buildings, industrial sites, railcars, pipe racks, arenas, bridges, etc.

- Easy installation — either in-house maintenance personnel under the supervision of an installation technician, or by a certified Xenon installer
- Stainless steel components withstand harsh environments
- Söll System Design Software calculates specifications for any application; easy to navigate and available in multiple languages
- Worker attaches using a shock-absorbing lanyard and full-body harness

Contact Miller Customer Service for complete details.



Connector Shuttle

Double-locking mechanism simple enough to operate with one hand. Stainless steel construction with no moveable parts; ideal for harsh, highly-corrosive environments.



4-in-1 Shock Absorber

Serves as shock absorber, turnbuckle, tension indicator and fall indicator; provides easy and safe access/exit.



Intermediate Brackets

May be replaced without disassembling or replacing the stainless steel cable.

Söll GlideLoc® Fixed Rail Ladder Climbing Systems

The innovative GlideLoc Ladder Climbing System can be engineered as an integral component of a new fixed ladder system, or retrofit to an existing fixed ladder. Available with a variety of accessory options to meet specific needs. Designed for ladder applications in telecommunications, utilities, industrial facilities, drilling rigs/platforms, shipbuilding, crane installations and confined space.

- The only ladder system offering ergonomic support since the user can lean forward or back while ascending/descending, reducing fatigue; ideal for closed-cage environments
- The unique Comfort™ fall arrest shuttle glides smoothly along the rail and maintains a continuous 3-point contact, allowing hands-free operation for greater mobility
- Additional design components provide horizontal movements without the need to disconnect from the system
- Available in aluminum, galvanized steel or stainless steel construction



#22697
Comfort
Fall Arrestor

Basic Rail Components

Model	Description
14614	Galvanized steel rail approx. 15 ft. (4.48m) length
14613	Galvanized steel rail approx. 7.5 ft. (2.24m) length
14664	Aluminum rail approx. 15 ft. (4.48m) length
15728	Aluminum rail approx. 7.5 ft. (2.24m) length
10903	Rung clamp for diameters <1" (25mm)
14804	Rung clamp for diameters 1" – 1.25" (25mm – 32mm)
14805	Rung clamp for diameters 1.25" – 1.75" (32mm – 44mm)
21050	Top end stop
21049	Bottom end stop
11634	Rigid end stop
22697	Comfort fall arrestor

Options: A variety of accessories are available that meet virtually any height safety need. For any corrosive environment, **stainless steel material is available.**

Accessories



1. Rotary Exit Section

Allows climbers to exit top end of rail system and move safely onto platform behind the ladder. Other methods of safe exit at top of climb are also available.

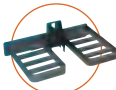

2. Folding Footrests

Provides a rest platform that conveniently folds out of the way for added safety. Resting and working platforms also available.



3. Turntable

Allows climber to transfer to horizontal track without disconnecting.



4. Exit Section

Allows the climber to release the shuttle from the rail.

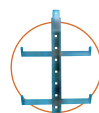

Ladder/Rail Combination

Integrated ladder/rail combination systems are available for applications without existing climbing structures.

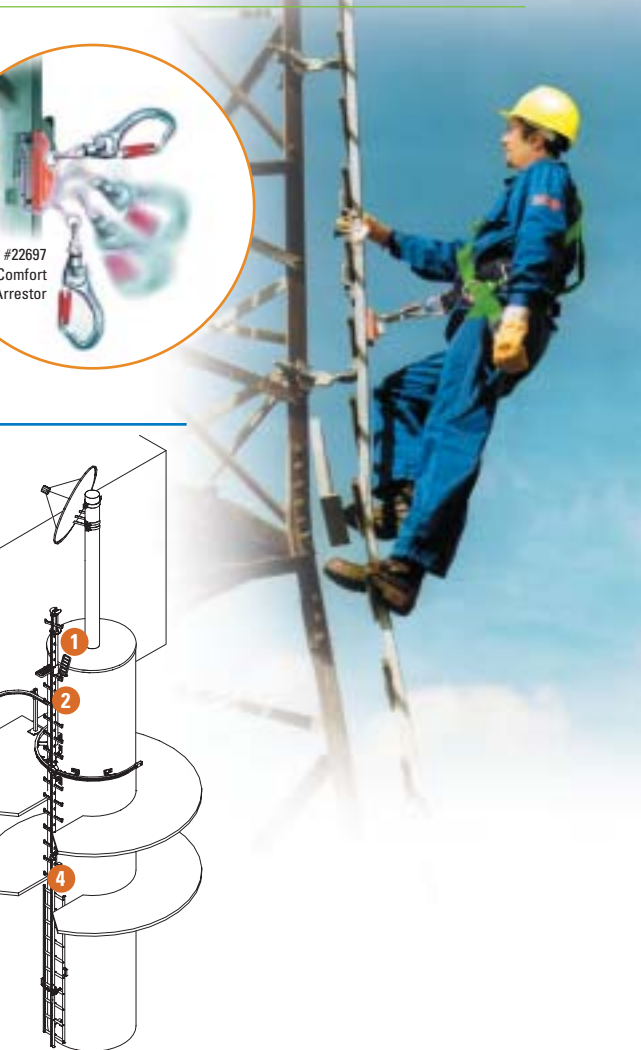
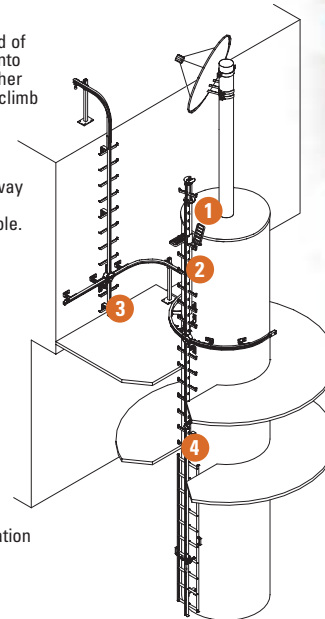

Miller TranScendor® Cable Climbing System

A permanently installed, flexible cable system, the Miller TranScendor is the ultimate in continuous fall protection for climbing fixed ladders.

- Complete system package allows for quick, easy, do-it-yourself installation and inspection for lower cost of ownership
- Unique lifeline tensioner prevents ladder rung deformation and indicates when the lifeline is properly adjusted
- Quick-link design for trouble-free cable installation
- Cable guides are fully convertible to accommodate low and high wind conditions increasing versatility
- Provides fall protection for up to four workers simultaneously, increasing overall productivity
- Durable cable sleeve locks instantly in the event of a fall and easily attaches to the cable

Complete Miller TranScendor System

All TranScendor Systems include a top bracket assembly with shock absorber, a bottom bracket assembly with lifeline tensioner, 3/8-inch (9.5mm) galvanized steel cable wire rope lifeline, all necessary hardware, cable guides (when applicable) and instruction manual.

Model	Description
TRS/30FT	30' (9m) TranScendor vertical climbing system
TRS/40FT	40' (12m) TranScendor vertical climbing system
TRS/50FT	50' (15m) TranScendor vertical climbing system
TRS/70FT	70' (21m) TranScendor vertical climbing system
TRS/100FT	100' (30.5m) TranScendor vertical climbing system
TRS/150FT	150' (46m) TranScendor vertical climbing system
TRS/200FT	200' (61m) TranScendor vertical climbing system
TRS/300FT	300' (91m) TranScendor vertical climbing system
TRS/400FT	400' (122m) TranScendor vertical climbing system
TRS/500FT	500' (152m) TranScendor vertical climbing system
TRIK	TranScendor installation kit (specify TranScendor System length)

Note: A harness with a front D-ring is required for use with the TranScendor System.

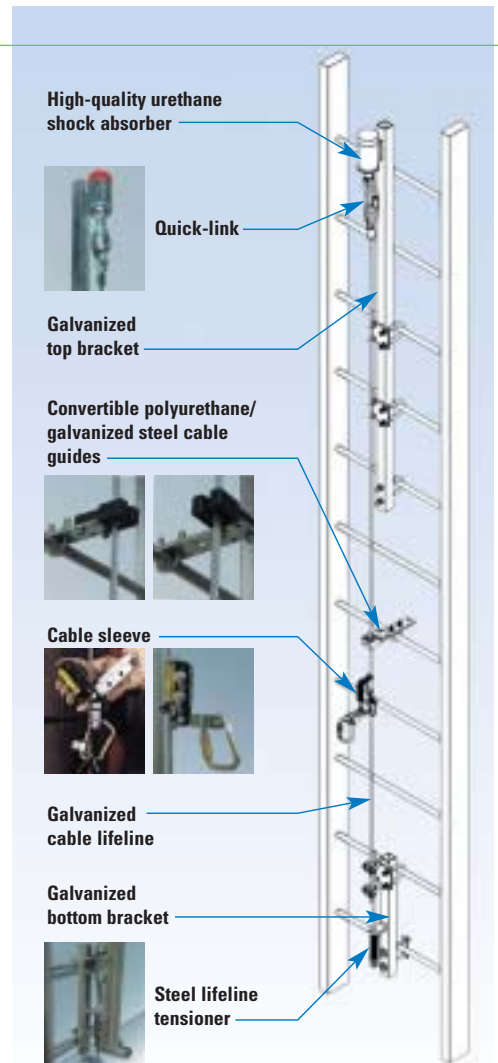

Söll PivotLoc® Foldable Ladder System

Söll PivotLoc is a foldable ladder system that incorporates the GlideLoc fixed rail ladder climbing technology. Uniquely designed to open and close, the PivotLoc system combines safety and security in ladder applications.

- Restricts access when folded closed, providing a slim, unobtrusive appearance; an effective alternative to a security cover plate
- Reliable fall protection solution for height access and work positioning
- Lightweight and easy to use; constructed of corrosion-resistant aluminum
- Complete with entry point, locking device and connection components

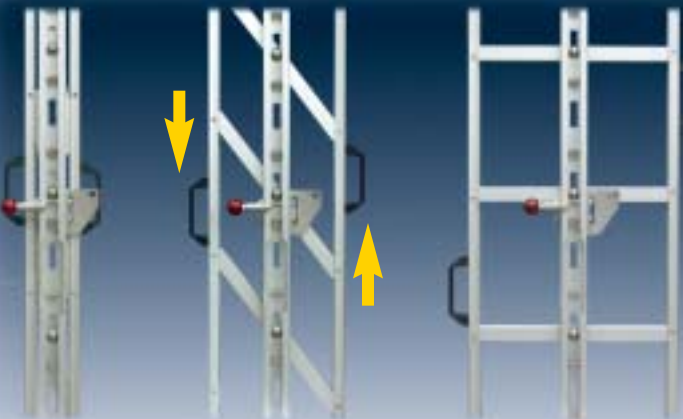

Model	Description
23281	PivotLoc w/coupling part for steel ladder 9.186' (2.8m)
23193	PivotLoc w/coupling part for aluminum ladder 9.186' (2.8m)

Note: PivotLoc can be used in conjunction with Söll Y-Spar and Twin Ladder Systems.

Miller Confined Space Equipment

Miller MightEvac® Self-Retracting Lifeline with Emergency Retrieval Hoist

The Miller MightEvac combines the superior performance and reliability of the best-selling MightyLite Self-Retracting Lifeline Series with a quick-activating retrieval mechanism for emergency evacuation.

- No annual factory recertification required*
 - Significant long-term savings/lower cost of ownership
- 20% lighter than competitive models
- Promotes quick and easy rescue with a 4:1 mechanical advantage (average speed of 25 ft. [7.6m] per minute)
- 310 lb. (1.4kN) weight capacity
- For emergency evacuation only
- Corrosion-resistant stainless steel/aluminum components
- Convenient, heavy-duty carrying handle
- Available in galvanized or stainless steel wire rope and Kevlar rope in lengths of 50 ft. (15m), 100 ft. (30m) and 130 ft. (40m), or Kevlar rope models in lengths of 40 ft. (12.2m) Model MR40K/40FT, and 80 ft. (24.4m) Model MR80K/80FT.



No annual factory recertification required

*Does not apply to Canada due to CSA Z259.2.2-98 requirements. Must be inspected by a Miller authorized service center if involved in a fall or if fails user visual or function inspection.

MIGHTEVAC SRL UNITS			COMPLETE CONFINED SPACE SYSTEMS*			
Length of Wire Rope	MightEvac Unit** w/Galvanized Wire Rope	MightEvac Unit w/Mounting Bracket	MightEvac Unit w/7-foot (2m) Tripod & Mounting Bracket	MightEvac Unit w/7-foot (2m) Tripod, Mounting Bracket & ManHandler Hoist	MightEvac Unit w/9-foot (2.7m) Tripod & Mounting Bracket	MightEvac Unit w/9-foot (2.7m) Tripod, Mounting Bracket & ManHandler Hoist
50' (15m)	MR50G/50FT	MR50GB/50FT	MR50GC/50FT	MR50GCM/50FT	MR50GX/50FT	MR50GXM/50FT
100' (30m)	MR100G/100FT	MR100GB/100FT	MR100GC/100FT	–	MR100GX/100FT	–
130' (40m)	MR130G/130FT	MR130GB/130FT	MR130GC/130FT	–	MR130GX/130FT	–

*Confined Space Systems also include a pulley, carabiner and two heavy-duty equipment bags.

**For stainless steel wire rope, change the "G" to an "S" in the corresponding model number (Ex: MR50G/50FT becomes MR50S/50FT and MR130GC/130FT becomes MR130SC/130FT).

Note: ManHandler Hoist only available in 65 ft. (18m) and 100 ft. (30m) lengths.

For daily personnel/material handling activities



Miller ManHandler® Hoist/Winch

The Miller ManHandler Hoist is the perfect solution for a range of applications including confined space entry, rescue, positioning and personnel/material handling. A secondary fall arrest system is recommended for fall protection.

- Compact, durable steel construction
- Smooth, controlled winding action
- Effortless lifting and lowering with 5:1 gear ratio
- Anti-backlash crank handle braking system prevents freewheeling
- Built-in mounting bracket
- 350 lb. (1.6kN) working capacity

Model	Description
8442/65FT*	ManHandler hoist w/65' (20m) of galvanized wire rope
8442/100FT*	ManHandler hoist w/100' (30m) of galvanized wire rope
8440/60FT*	Material winch w/60' (18m) of galvanized wire rope
8441/88FT*	Material winch w/88' (27m) of galvanized wire rope

*Also available with stainless steel wire rope by adding "SS" after model number (Ex: 8442SS/65FT).

New!

Miller[®] **DuraHoist[™]** **Confined Space Systems**

Miller[®] DuraHoist[™] Confined Space Systems provide safe, lightweight and portable solutions for a variety of confined space applications, including confined space entry, rescue, positioning and personnel/material handling.

- Lightweight, high-strength aluminum construction for easy handling and long service life
- Modular design adapts to many applications, lowering cost of ownership and providing effective safety solutions
- A variety of portable and fixed bases are available for many confined space applications



Portable Fall Arrest Anchor Post (DH-AP-1)

w/Davit Arm (DH-AP-3)

Complete 4-Piece Hoist System

w/50 ft. (15m) Winch (DH-1)



Model	Description
DH-1	Complete 4-piece hoist system w/50' (15m) winch
DH-AP-1	Portable Fall Arrest Anchor Post
DH-AP-3	Rescue Davit Arm for Portable Fall Arrest Anchor Post (DH-AP-1)
DH100/70FT*	100 Series digital winch (70' [21m])

*Additional lengths available.

For complete details, contact your nearest Miller Distributor or call Miller Technical Support at 800/873-5242.

Miller Tripod

The Miller Tripod is the anchorage connector for typical confined space and rescue systems.



- Available in 7 ft. (2m) and 9 ft. (2.7m) models
- Lightweight, high-strength aluminum construction
- Withstands up to 5,000 lbs. (22kN) of vertical pull
- Adjustable legs with integral push pins, ideal for uneven surfaces
- Independent leg locking feature hold legs securely in place
- Safety chain and tripod feet with rubber skid pads and serrated edge prevent slippage in icy conditions
- Available with reflective tape

Model	Description
51	7' (2m) high-strength aluminum Tripod
51X	9' (2.7m) high-strength aluminum Tripod

Miller Quad Pod

For applications where a traditional tripod cannot be used, the Quad Pod provides an excellent alternative.



#8464

- Versatile, two-piece unit consists of a boom and base
- Base features folding legs and a wheel for easy transport
- Boom rotates 360 degrees for maximum maneuverability and features a mounting plate to accommodate entry and retrieval units

Also available with permanent bases for mounting to truck beds or at confined space entrances while transporting the boom between locations.



Optional Base:
#8464-3L, 24" (610mm)
High Permanent Base

Optional Base:
#8464-3, 3" (76mm)
High Permanent Base

Model	Description
8464	Quad Pod System (Includes base with folding legs and boom)
8464-1	Standard Quad Pod Base with folding legs
8464-2	Quad Pod Boom
8464-3	3" (76mm) high permanent Quad Pod Base
8464-3L	24" (610mm) high permanent Quad Pod Base

Miller Davit Mounting System

The Miller Davit Mounting System can be mounted on a ladder (with 12-inch [305mm] spacing between rungs) extending into a manhole, vault or tank, and serves as an anchorage connector for entry and retrieval units, winches, or other mechanical devices. Ideal for tight work environments where traditional tripod and quad pods are not practical.

- The complete system includes mounting plate, main tubing, retrieval unit bracket and pulley head assembly.



Optional Base:
#8847-8 Permanent
Davit System
Mounting Base

Model	Description
8847-9*	Complete Davit System
8847-8	Permanent Davit System Mounting Base

*Consists of davit arm (8847-2), base (8847-1), self-retracting lifeline bracket (8847-3), and pulley head assembly (8847-4).



Miller Rescue/Descent Equipment

Miller Universal Rescue System

The Miller Series 70 Universal Rescue System is a lightweight, compact, versatile access and retrieval rope system. Simple, one-person operation, the rope control handle allows the user to easily ascend and descend the rope line. Should an emergency rescue situation occur, a top-side worker may activate the system to retrieve the user.

Ideal for refineries, grain elevators, subways, fire departments, breweries, chairlifts, window washing, confined spaces, shipbuilding, transmission towers, power plants, offshore drilling and bridge inspection.

Series 70 System

- Aluminum head assembly with roller pulley and anti-reversing lock
- Kernmantle rope with a tensile strength of 5600 lbs. (25kN) and high-temperature resistance to 360°F (182°C)
- Rope control handle with friction locking device and with permanently attached Manyard shock-absorbing lanyard
- Two carabiners
- Convenient carrying bag

Model	Description
70-100/100FT*	Series 70 System w/25' (7.6m) working length
70-200/200FT*	Series 70 System w/50' (15m) working length
70-400/400FT*	Series 70 System w/100' (30m) working length
70-500/500FT*	Series 70 System w/125' (38m) working length
70-C	Rope control handle w/attached Manyard shock-absorbing lanyard

*Rope length is divided by four to determine maximum working length.



A secondary fall arrest system is recommended.



Optional:
Bos'n Chair
#6004NS

Miller Descent Device

The Miller Manual Descent Device is designed for a variety of applications where smooth, controlled descent from an elevated position is required. The device, controlled by the user, allows for making descent fast or slow; decelerating and stopping by applying slight outward pressure on the free end of the line; and locking in a stationary position for a hands-free work environment.

The device must be ordered with Miller brand descent rope.

Model	Description
8113*	Descent Device Unit
8195	Polyester-braided Descent Rope

*Model 8113 Descent Device Unit must be ordered with Model 8195 polyester-braided rope (please specify length).

Optional:
Bos'n Chair #6004NS

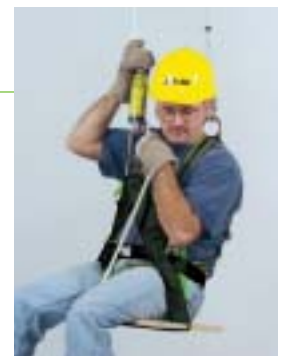

Miller SafEscape™ Controlled Descent/Self-Rescue System

Miller SafEscape Controlled Descent/Self-Rescue System offers a safe, timely solution for emergency height rescue. The SafEscape descender is specially designed for smooth, automatic vertical and angular controlled descent from overhead cranes, towers, aerial lifts, oil derricks, platforms or other elevated work areas.

Model	Description
AG10KT	Complete Miller SafEscape System includes SafEscape rescue unit, 3/8" (9.5mm) polyester rope, rescue harness, cross-arm strap, anchorage connector/carabiner, retrieval yoke and convenient carrying bag
AG-10	Miller SafEscape automatic descender with rescue rope only (specify rope length)
000109/URK	Miller rescue harness



Fall Prevention and Protection Training

Training is an integral part of a Fall Protection Program. To maintain a safe and productive work environment, it is essential that employees working at heights:

- Recognize fall hazards
- Evaluate the risk posed by each hazard
- Control the hazard through preventative or protective measures

Miller/Troll® Training

- Field-experienced professional instructors
- Training programs that provide the awareness, knowledge and skills necessary to ensure safety on the jobsite
- Customized on-site fall prevention and protection training available
- A series of pre-scheduled Open Enrollment Training courses conducted annually in select cities throughout North America, with primary focus on the two-day *Competent Person* Training program created for facility and site supervisors who must serve as the *Competent Person* required by OSHA 1926.32(f), 1926.500 and 1910 standards

“Gravity Kills...Defy It” Video

This 20-minute comprehensive fall prevention and protection guidelines video is an excellent training tool for safety professionals.

The video includes:

- In-depth review of fall arrest systems
- Dynamic drop tests to demonstrate fall forces
- Easy-to-calculate fall clearance data
- Overview of personal fall arrest system products

Open Enrollment Training Programs

Register Now

- Experienced instructors
- Live demonstrations and hands-on training
- Addresses site-specific variables and performance requirements of fall prevention and protection

COMPETENT PERSON I TRAINING Course Length: 16 hours

A two-day course designed for safety directors, foremen, crew chiefs and job site superintendents who must serve as the *competent person* as defined and required by OSHA.

COMPETENT PERSON LEVEL INSPECTOR'S TRAINING Course Length: 8 hours

A one-day advanced level training course for individuals serving as the *competent person* responsible for inspecting fall arrest equipment and systems.

COMPETENT PERSON REFRESHER COURSE Course Length: 8 hours

A one-day refresher course designed for safety directors, foremen, crew chiefs and job site superintendents who have already completed the *Competent Person I* Training course.

TRAINING FACILITATORS CLASS Course Length: 32 hours

A four-day comprehensive training course designed for supervisory personnel, safety managers, foremen, crew chiefs and job site superintendents who are responsible for providing fall protection training.

TOWER CLIMBER SAFETY CLASS Course Length: 16 hours

A two-day intermediate level course for supervisory personnel, safety managers, foremen, crew chiefs and job site superintendents designated as the *competent person* in regard to job site fall protection responsibilities.



All Miller brand fall protection products meet applicable OSHA, ANSI and CSA requirements. In addition, CE certified products are available, ask for details.

The fall protection industry has been bombarded with regulations and standards. Understanding these requirements is key to ensuring a safe work environment. The Occupational Safety and Health Act (OSHA) under Title 29 of the Code of Federal Regulations (29 CFR) assures and enforces safe and healthful working conditions for general industry and construction in the United States. Under the Act, employers have the duty of providing their workers with a place of employment free from recognized safety and health hazards. It's the law.

The American National Standards Institute (ANSI) and the Canadian Standards Association (CSA) are voluntary organizations made up of manufacturers and consumers that establish product performance standards for fall protection safety. Meeting the standards indicates that products pass accepted testing procedures. The standards are not enforceable as law, however many OSHA regulations are adopted from ANSI standards.

Employers should obtain copies of the regulations that apply to their work operations by writing to:

Occupational Safety and Health Administration (OSHA)
200 Constitution Avenue, N.W., Washington, DC 20210
www.osha.gov

American National Standards Institute, Inc. (ANSI)
11 West 42nd Street, New York, NY 10036
212/642-4900

Canadian Standards Association (CSA)
178 Rexdale Boulevard
Etobicoke, Ontario, Canada M9W 1R3
416/747-4231

British Standards Online (BS EN)
www.bsonline.techindex.co.uk

European Document Research (EC)
www.europeandocuments.com

OSHA Regulations Governing Construction (29 CFR PART 1926)

Subpart E covers some requirements for personal protective equipment.

Safety Belts, Lifelines and Lanyards 1926.104
Safety Nets 1926.105

Subpart L covers scaffolds. 1926.450-454

Subpart M covers fall protection in its entirety and explains when and where fall protection systems are required and for what construction work activities. It also defines system component requirements.

Scope, Application and Definitions 1926.500
Duty to Have Fall Protection 1926.501
Fall Protection Systems Criteria and Practices 1926.502
Training Requirements 1926.503

Subpart R covers issues specific to steel erection.

Fall Protection (Proposed) 1926.750

Subpart X covers ladders. 1926.1053

OSHA Regulations Governing General Industry (29 CFR PART 1910)

Subpart D mentions a few specific fall protection requirements relative to walking/working surfaces.

Fixed Ladders – Ladder Safety Devices 1910.27(d)(5)
Safety Requirements for Scaffolding –
Boatswain's Chairs 1910.28(j)(4)

Subpart F covers fall protection as it pertains to powered platforms, manlifts, and vehicle-mounted work platforms.

Powered Platforms for Building Maintenance 1910.66
Personal Fall Arrest Systems 1910.66
Appendix C

Subpart J covers general environmental controls in which confined spaces are addressed.

Permit-Required Confined Spaces 1910.146

Subpart R is for issues specific to special industries.

Telecommunications 1910.268
Electric Power Generation, Transmission
and Distribution 1910.269

Additional Industry-Specific OSHA Regulations

Marine Terminals 1917
Longshoring 1918

ANSI Standards

Scaffolding A10.8
Personnel and Debris Nets for Construction and Operations A10.11-1989
Construction and Demolition Operations A10.32-2004
Ladder Safety Devices A14.3
Confined Space Z117.1
Safety Requirements for Personal Fall Arrest Systems,
Subsystems and Components Z359.1-1992

CSA Standards

Safety Belts and Lanyards Z259.1-95
Fall Arresters, Vertical Lifelines and Rails Z259.2.1-98
Self-Retracting Devices for
Personal Fall Arrest Systems Z259.2.2-98
Descent Control Devices Z259.2.3-99
Linemen's Body Belt and Safety Straps Z259.3-M1978
Full-Body Harnesses Z259.10-M90
Shock Absorber for Personal Fall Arrest Systems Z259.11-M92
Connecting Components Z259.12-01
Wood Pole Climbing Z259.14-01

British Standards

Personal Protective Equipment Against Falls from Heights
Retractable-Type Fall Arresters BS EN 360:1993
Personal Protective Equipment Against Falls from Heights
Retractable-Type Fall Arresters BS EN 360:2002
Personal Protective Equipment Against Falls from Heights
Connectors BS EN 362:1993
Personal Protective Equipment Against Falls from Heights
Fall Arrest Systems BS EN 363:2002
Personal Protective Equipment Against Falls from Heights
Test Methods BS EN 364:1993
Personal Protective Equipment Against Falls from Heights
General Requirements for Instructions for Use and Markings BS EN 365:1993

European Community (CE Standards)

Directive for Personal Protective Equipment 89/686/EEC

Australia / New Zealand Standards

Industrial Fall Arrest Systems and Devices AS/NZS 1891.1-1995/Amdt 4-1999
Safety Belts and Harnesses

Fall Clearance Requirements



SELECT THE PROPER FALL PROTECTION EQUIPMENT

Shock-Absorbing Lanyard or Self-Retracting Lifeline?

Always know your fall distance and select proper equipment to meet the fall clearance.



#9051/BK

Splat Indicator

For quick and easy alternative to calculating your fall distance, use the Splat Indicator.

- Similar to a plumb bob, simply attach the device to an anchorage or to the lanyard at the anchoring snap hook and lower the weight using the attached string
- If the weight strikes a lower level, then a higher anchorage must be selected
- If a higher anchorage is not accessible, a shorter lanyard or a fall limiter should be used

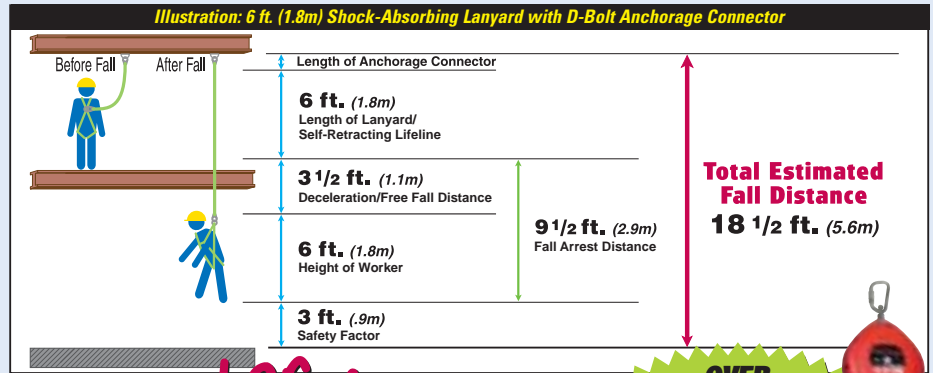

Remember...

UNDER
18 1/2 ft. (5.6m)
always use a
Self-Retracting Lifeline.

OVER
18 1/2 ft. (5.6m)
a Shock-Absorbing Lanyard
or Self-Retracting Lifeline
can be used.

Always calculate your fall distance before selecting your fall protection equipment.



WARNING

This document provides an overview of fall protection products available from Bacou-Daloz and care has been taken to assure the accuracy of the data. It does not provide important product warnings and instructions. Bacou-Daloz recommends all users of fall protection equipment undergo thorough training, and that all warnings and instructions provided with the products be thoroughly read and understood prior to use. Failure to read and follow all product warnings and instructions could result in serious injury or death.

Miller Tool Lanyards

Prevent tools from dropping that can cause serious injuries on the jobsite.

Bandit™ Tool Lanyard

Lanyard conveniently attaches to the user's belt. Tools are attached with the carabiner or by cinching the cord around tool.

WristBandit Tool Holder

Conveniently attaches to user's wrist with Velcro®. Tools are attached by cinching the lanyard cord around tool.



#9077X/12

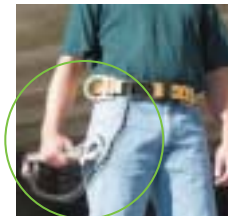

#9077 Bandit Tool Lanyard



#9076 WristBandit Tool Holder

Model	Description
9076/BK	WristBandit Tool Holder attaches to the user's wrist
9077	Bandit Tool Lanyard attaches to the user's belt
9077X/12	Consists of a box of 12 Bandit Tool Lanyards

Miller Technical Support
800/873-5242
www.millerfallprotection.com

**GRAVITY
KILLS**

DEFY IT!

MILLER® FALL PROTECTION PRODUCTS
TOTAL SATISFACTION ASSURANCE

At Bacou-Dalloz, we have been providing quality Miller brand fall protection equipment to millions of workers worldwide since 1945.

LIMITED LIFETIME WARRANTY
BACKED BY OVER 60 YEARS IN THE FALL PROTECTION BUSINESS

We sincerely believe that our fall protection equipment is the best in the world. Our products endure rigorous tests to ensure that the fall protection equipment you trust is manufactured to the highest standards. Miller fall protection products are tested to withstand normal wear and tear, but are not indestructible and can be damaged by misuse. Our Limited Lifetime Warranty does not apply to normal wear and tear or abusive treatment of the product.

In the unlikely event that you should discover defects in either workmanship or materials, under our Limited Lifetime Warranty we will repair or replace the product at our expense. If a replacement is necessary and your product is no longer available, a comparable product will be substituted. Should a product issue surface, contact us at 800/873-5242.

Manufacturing specifications are subject to change without notice.

This equipment should only be used in conjunction with the manufacturer's instructions. Failure to follow instructions could result in serious injury or fatality.

MILLER®

Toll Free 800/873-5242 Fax 800/892-4078
Phone 814/432-2118 Fax 814/432-2415
www.millerfallprotection.com

For more information or to place an order,
please contact your Miller® distributor:

LMFPC/0806/40M/PMI